

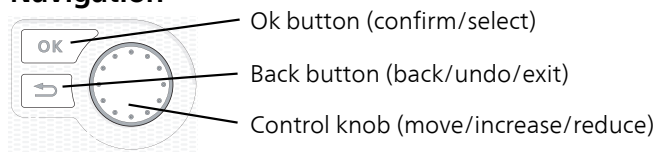

Installer manual
SMO 20
Control module

Quick guide

Navigation



A detailed explanation of the button functions can be found on page 29.

How to scroll through menus and make different settings is described on page 31.

Set the indoor climate

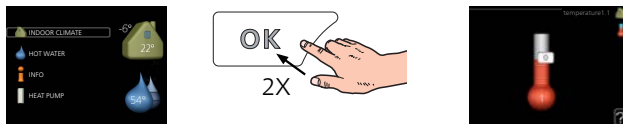

The mode for setting the indoor temperature is accessed by pressing the OK button twice, when in the start mode in the main menu.

Increase hot water volume

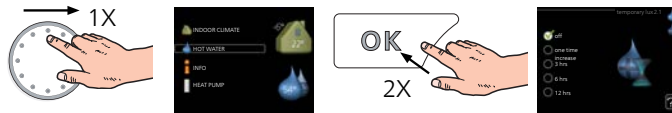

To temporarily increase the amount of hot water (if a hot water heater is installed to your SMO 20), first turn the control knob to mark menu 2 (water droplet) and then press the OK button twice.

Table of Contents

1 Important information _____	4	9 Service _____	41
Safety information _____	4	Service actions _____	41
2 Delivery and handling _____	7	10 Disturbances in comfort _____	44
Wall installation _____	7	Troubleshooting _____	44
Supplied components _____	7	Additional heating only _____	45
3 The Control Module Design _____	8	11 Accessories _____	46
Component positions _____	8	12 Technical data _____	48
Electrical components _____	8	Dimensions _____	48
4 Pipe connections _____	9	Technical specifications _____	49
General _____	9	Energy labelling _____	50
Compatible NIBE air/water heat pumps _____	9	Electrical circuit diagram _____	51
Symbol key _____	9	Item register _____	55
Temperature sensor installation on pipe _____	10	Contact information _____	59
Docking alternatives _____	10		
5 Electrical connections _____	15		
General _____	15		
Accessibility, electrical connection _____	16		
Cable lock _____	17		
Connections _____	18		
Optional connections _____	21		
Connecting accessories _____	26		
6 Commissioning and adjusting _____	27		
Preparations _____	27		
Commissioning with NIBE air/water heat pump _____	27		
Commissioning with additional heating only _____	27		
Check the reversing valve _____	27		
Check AUX socket _____	27		
Cooling mode _____	27		
Start guide _____	28		
7 Control - Introduction _____	29		
Display unit _____	29		
Menu system _____	30		
8 Control _____	33		
Menu 1 - INDOOR CLIMATE _____	33		
Menu 2 - HOT WATER _____	34		
Menu 3 - INFO _____	34		
Menu 4 - MY SYSTEM _____	35		
Menu 5 - SERVICE _____	36		

1 Important information

Safety information

This manual describes installation and service procedures for implementation by specialists.

The manual must be left with the customer.

This appliance can be used by children aged from 8 years and above and persons with reduced physical, sensory or mental capabilities or lack of experience and knowledge if they have been given supervision or instruction concerning use of the appliance in a safe way and understand the hazards involved. Children shall not play with the appliance. Cleaning and user maintenance shall not be made by children without supervision.

Rights to make any design or technical modifications are reserved.

©NIBE 2017.



NOTE

SMO 20 must be installed via an isolator switch with a minimum breaking gap of 3 mm.



NOTE

If the supply cable is damaged, only NIBE, its service representative or similar authorised person may replace it to prevent any danger and damage.

Symbols



NOTE

This symbol indicates danger to person or machine .



Caution

This symbol indicates important information about what you should observe when maintaining your installation.



TIP

This symbol indicates tips on how to facilitate using the product.

Marking

CE

The CE mark is obligatory for most products sold in the EU, regardless of where they are made.

IP21

Classification of enclosure of electro-technical equipment.



Danger to person or machine.



Read the User Manual.

Serial number

The serial number can be found on the top of the cover for the control module and in the info menu (menu 3.1).

Serial number



Caution

You need the product's (14 digit) serial number for servicing and support.

Recovery



Leave the disposal of the packaging to the installer who installed the product or to special waste stations.

Do not dispose of used products with normal household waste. It must be disposed of at a special waste station or dealer who provides this type of service.

Improper disposal of the product by the user results in administrative penalties in accordance with current legislation.

Inspection of the installation

Current regulations require the heating installation to be inspected before it is commissioned. The inspection must be carried out by a suitably qualified person. Fill in the page for information about installation data in the User manual.

✓	Description	Notes	Signature	Date
	Electricity (page 15)			
	Communication, heat pump			
	Connected supply 230 V			
	Outside sensor			
	Temperature sensor, hot water charging			
	Temperature sensor, hot water top			
	Temperature sensor, external flow line			
	Temperature sensor, external supply line after electric heater			
	Temperature sensor, external return line			
	Charge pump			
	Shuttle valve			
	AUX1			
	AUX2			
	AUX3			
	AUX4			
	AUX5			
	AUX6			
	AA2-X4			
	Miscellaneous			
	Checking additional heater			
	Checking the function of the reversing valve			
	Checking charge pump function			
	Completed installation check of heat pump and associated equipment			

2 Delivery and handling

Wall installation

NOTE
 For wall mounting, use screws suitable for the surface.

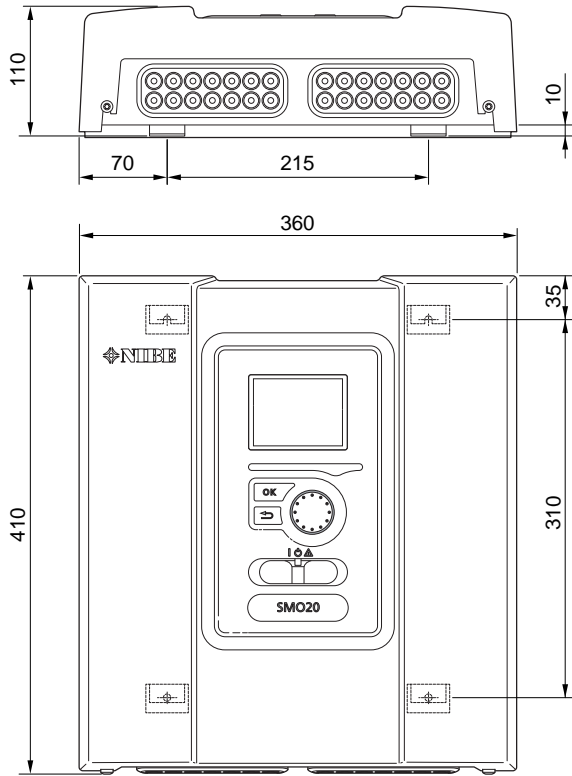

Use all mounting points and install SMO 20 upright flat against the wall without any part of the control module protruding out beyond the edge of the wall.

Leave at least 100 mm free space around the control module to facilitate access and cable routing on installation and service.

NOTE
 Screws for removing the front cover are reached from underneath.

Supplied components



Outside sensor



Heating pipe paste

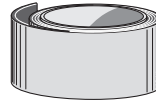

Insulation tape

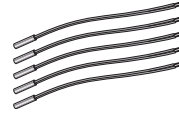

Temperature sensor



Aluminium tape

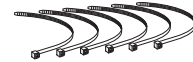

Cable ties

3 The Control Module Design

Component positions

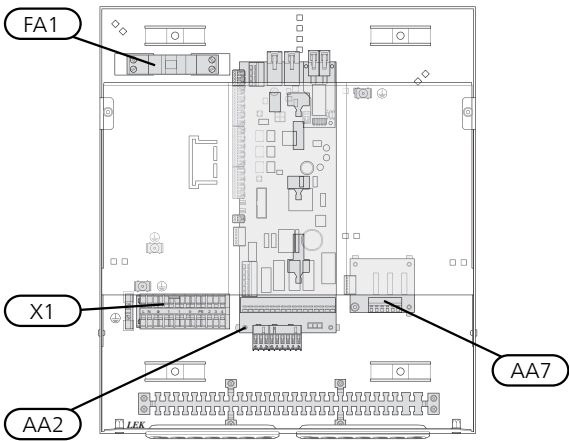
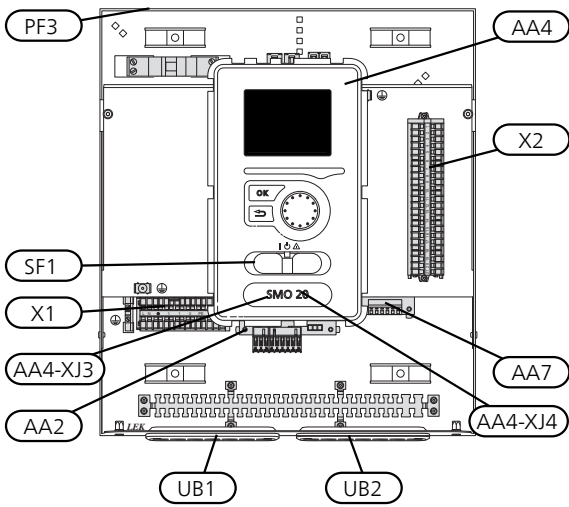

Electrical components

- AA2 Base card
- AA4 Display unit
 - AA4-XJ3 USB socket
 - AA4-XJ4 Service outlet (No function)
- AA7 Extra relay circuit board
- FA1 Miniature circuit breaker, 10 A
- X1 Terminal block, incoming electrical supply
- X2 Terminal block, control signal circulation pump, sensors AUX inputs and heat pump
- SF1 Switch
- PF3 Serial number plate
- UB1 Cable grommet, incoming supply electricity, power for accessories
- UB2 Cable gland, signal

Designations in component locations according to standard IEC 81346-1 and 81346-2.

4 Pipe connections

General

















Pipe installation must be carried out in accordance with current norms and directives. See manual for compatible NIBE air/water heat pump for installation of the heat pump.

Compatible NIBE air/water heat pumps

Compatible NIBE air/water heat pumps must be equipped with a control card that has at least the software version given in the following list. The control card version is displayed in the heat pump's display (if applicable) upon start-up.

Product	Software version
F2015	55
F2016	55
F2020	118
F2025	55
F2026	55
F2030	all versions
F2040	all versions
F2120	all versions
F2300	55
NIBE SPLIT HBS 05: AMS 10-6 + HBS 05-6 AMS 10-8 + HBS 05-12 AMS 10-12 + HBS 05-12 AMS 10-16 + HBS 05-16	all versions

Symbol key

Symbol	Meaning
	Shut-off valve
	Tapping valve
	Trim valve
	Shunt / reversing valve
	Safety valve
	Temperature sensor
	Expansion vessel
	Pressure gauge
	Circulation pump
	Particle filter
	Auxiliary relay
	Compressor
	Heat exchanger
	Radiator system
	Domestic hot water
	Under floor heating systems
	Cooling system

Temperature sensor installation on pipe

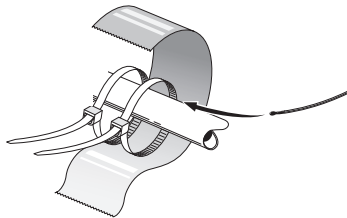

The temperature sensors are mounted with heat conducting paste, cable ties (the first cable tie is secured to the pipe in the middle of the sensor and the other cable tie is mounted approx. 5 cm beyond the sensor) and aluminium tape. Then insulate with supplied insulation tape.



NOTE

Sensor and communication cables must not be placed near power cables.

Docking alternatives

SMO 20 can be connected with other products from NIBE in several different ways, some of which are shown below (accessories may be required).

Further option information is available at www.nibe.eu and in the respective assembly instructions for the accessories used. See page 46 for a list of the accessories that can be used with SMO 20.

Installations with SMO 20 can produce heating and hot water. Cooling can also be produced, depending on which heat pump is used.

On cold days of the year when the access to energy from the air is reduced the additional heating can compensate and help to produce heat. The additional heating is also good to have as assistance if the heat pump ends up outside its working range or if it has been blocked for any reason.



NOTE

The heating medium side and the hot water side must be fitted with the necessary safety equipment in accordance with the applicable regulations.

This is the outline diagram. Actual installations must be planned according to applicable standards.

Explanation

AA25 SMO 20

BT1	Outdoor sensor ¹⁾
BT6	Temperature sensor, hot water charging ¹⁾
BT7	Temperature sensor, hot water top ¹⁾
BT25	Temperature sensor, external supply line ¹⁾
BT50	Room sensor
BT63	Temperature sensor, external supply line after electric heater
BT71	Temperature sensor, external return line ¹⁾
GP10	Circulation pump, Heating medium
GP15	Circulation pump, heating medium
QN10	Reversing valve, Hot water/Heating medium ²⁾
RM2	Non-return valve

AA29 Automatic shunt

BT25	Temperature sensor, external flow line
QN25	Shunt valve

EB1 Additional heat

EB1	Immersion heater
KA1	Auxiliary relay/Contactor ²⁾

EB20 Immersion heater

EB20	Immersion heater
QA1	Auxiliary relay/Contactor

EB101 Heat pump system

BT3	Temperature sensor, return line ³⁾
BT12	Temperature sensor, condenser supply line ³⁾
EB101	Heat pump
FL10	Safety valve
GP12	Charge pump ²⁾
QM1	Drain valve, Heating medium
QM31	Shut-off valve, Heating medium, Flow
QM32	Shut off valve, Heating medium, Return
QZ2	Filterball

EM1 External additional heat

CM5	Expansion vessel
EM1	Oil, gas, pellets or wood boiler
FL10	Safety valve

EQ1 Cooling system

BT64	Temperature sensor, cooling supply line ²⁾
CP6	Single jacket accumulator tank, cooling
GP13	Circulation pump, cooling
QN12	Reversing valve, Cooling/Heating ²⁾

Miscellaneous

CM1	Expansion vessel closed, Heating medium
CP1	Accumulator tank with hot water heating

CP5	Buffer vessel (UKV)
CP10	Accumulator tank with hot water heating
EB20	Immersion heater
FL2	Safety valve, Heating medium
GP32	Charge valve
KA1	Auxiliary relay/Contactor
RM1	Non-return valve
RN10	Trim valve

1) Included in and supplied SMO 20

2) Included in and supplied accessory

3) Included in and supplied NIBE heat pump (can vary depending on heat pump).

Designations according to standards 81346-1 and 81346-2.

Compatible NIBE air/water heat pump together with SMO 20 – docking step-controlled additional heat before the reversing valve for hot water as well as cooling function (4-pipe system)

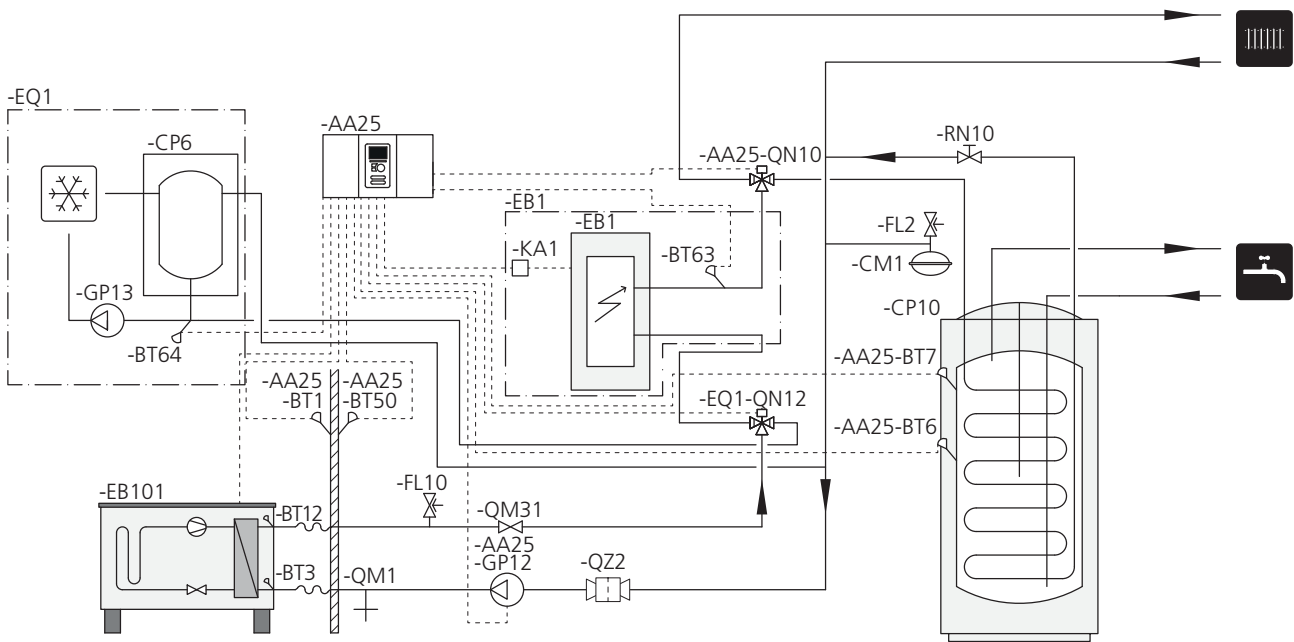

NOTE

NIBE does not supply all components in this outline diagram.

SMO 20 (AA25) starts and stops the heat pump (EB101) to meet the heat and hot water demand of the installation. At simultaneous heating and hot water demand the reversing valve switches (AA25-QN10) periodically between the climate system and the water heater/accumulator tank (CP10). When the hot water heater/accumulator tank is fully charged (CP10), the reversing valve switches (AA25-QN10) to the climate system.

Additional heat (EB1) is connected automatically when the power demand for the installation exceeds the heat pump capacity. This is used for both heating and charging hot water.

The additional heat can also be used if a higher temperature in the hot water is required than the heat pump can produce.

During cooling operation (requires compatible heat pump) the reversing valve (EQ1-QN12) switches to the cooling system (EQ1). If several simultaneous demands occur while there is a cooling demand the installation reacts differently. In event of a hot water demand the reversing valve (EQ1-QN12) switches back and hot water is produced until the demand is fulfilled. In event of a heating demand the reversing valve (EQ1-QN12) instead switches periodically between the demands. If the cooling demand is met, the reversing valve switches back to basic mode (heat/hot water).

Compatible air/water heat pump together with SMO 20 – docking step-controlled additional heat after the reversing valve for hot water as well as cooling function (4-pipe system)

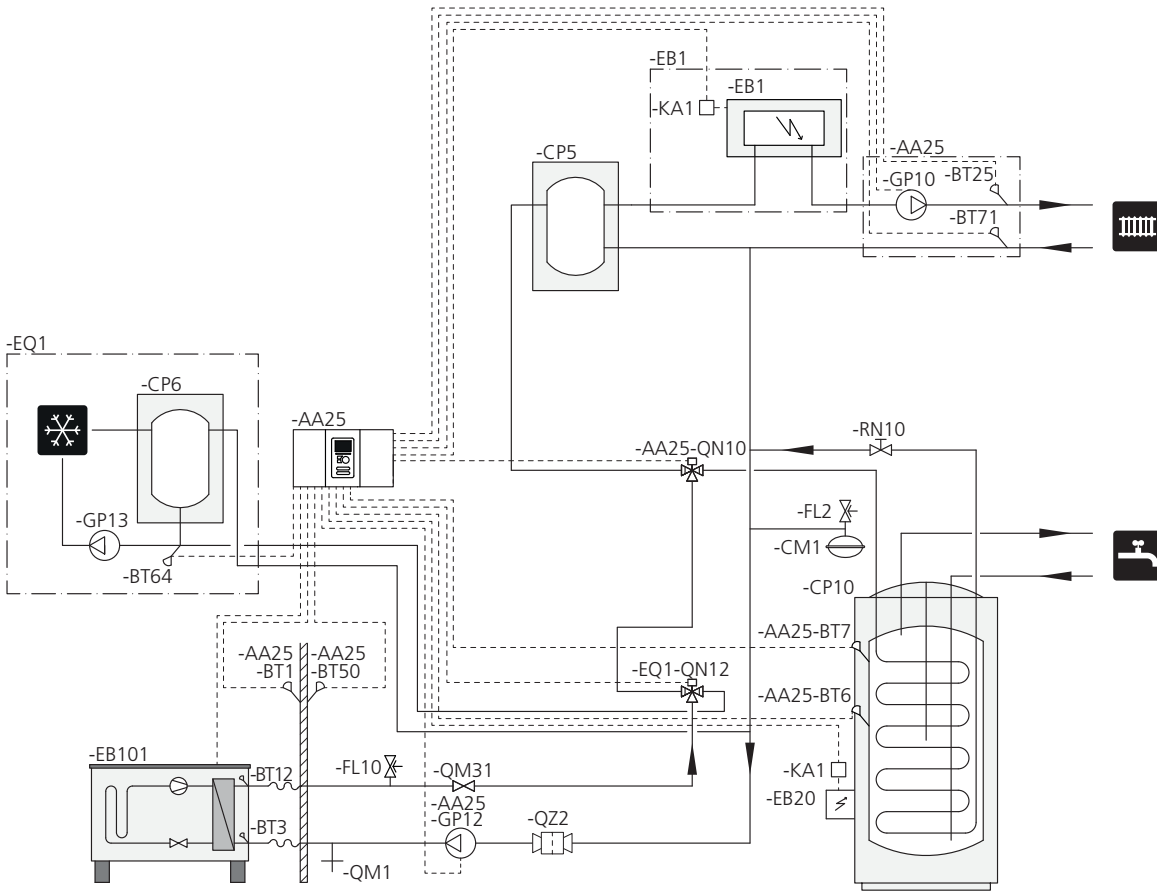

NOTE
 NIBE does not supply all components in this outline diagram.

This installations alternative is suitable for more complex installations with a focus on comfort.

SMO 20 (AA25) starts and stops the heat pump (EB101) to meet the heat and hot water demand of the installation. At simultaneous heating and hot water demand the reversing valve switches (AA25-QN10) periodically between the climate system and the water heater/accumulator tank (CP10). When the hot water heater/accumulator tank is fully charged (CP10), the reversing valve switches (AA25-QN10) to the climate system.

Additional heat (EB1) is connected automatically when the energy demand exceeds the heat pump capacity. Immersion heater (EB20) in the water heater/accumulator

or tank (CP10) is used during the time to produce hot water if the heat pump (EB101) is used for heating the building at the same time.

The immersion heater (EB20) can also be used if a higher temperature of hot water is required than the heat pump can produce.

During cooling operation (requires compatible heat pump), the reversing valve (EQ1-QN12) switches to the cooling system (EQ1). If several demands occur while there is a cooling demand, the installation reacts differently. In event of a hot water demand, the reversing valve (EQ1-QN12) switches back and hot water is produced until the demand is fulfilled. In event of a heating demand, the reversing valve (EQ1-QN12) instead switches periodically between the demands. When the cooling demand is met, the reversing valve switches back to basic mode (heat/hot water).

Active cooling (in 4-pipe system) is selected in menu 5.4 - soft in/outputs.

SMO 20 with wood boiler, accumulator tank and heat pump (floating condensing)

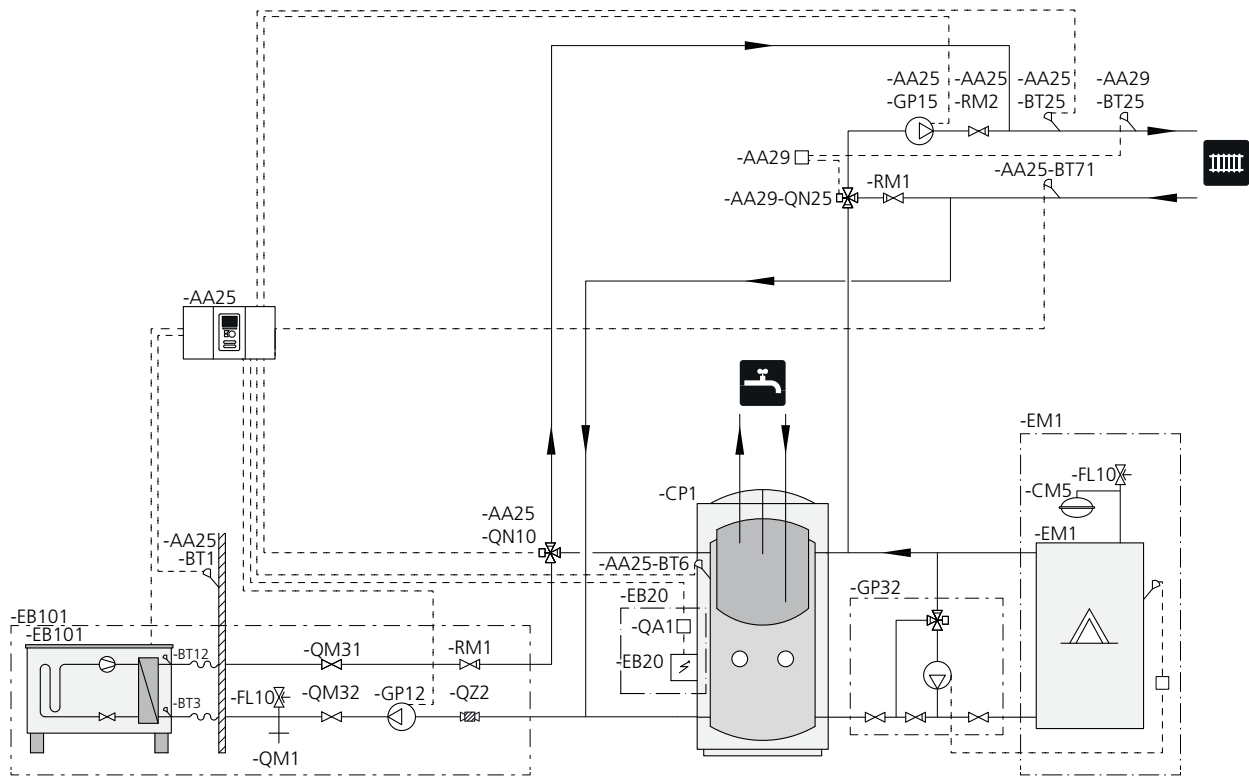

NOTE

NIBE does not supply all components in this outline diagram.

Air/water heat pump and SMO 20 for supplementing existing wood-fired installation, where the wood heater must be used as AUX function wood docking. Existing automatic shunt is used but is not controlled from SMO 20.

When the wood boiler (EM1) is fired, the heat in the accumulator tank (CP1) is used for hot water and as prioritised additional heat. The wood-fired installation's heating medium pump (AA25-GP15) starts.

If the temperature of the hot water sensor (AA25-BT6) drops below the temperature for hot water stop set in SMO 20, the heat pump (EB101) starts. The wood-fired installation's heating medium pump (AA25-GP15) is stopped and the heat pump's heating medium pump (EB101-GP12) starts. Hot water is charged via reversing valve (AA25-QN10) with the aid of the hot water sensor (AA25-BT6).

As long as the hot water sensor (AA25-BT6) is below the temperature that blocks wood docking, degree minute control is used to control heat pump operation.

When blocking the heat pump, anti-freeze is secured with the aid of the heat pump's heating medium pump (EB101-GP12).

Connect the wood-fired installation's heating medium pump (AA25-GP15) to terminal block X4:15-17 on the base board (AA2) in SMO 20 (AA25).

Wood docking can be activated via the start guide or directly in the menu system, menu 5.2.4 - accessories and menu 5.4 - soft in/outputs.

5 Electrical connections

General

- Disconnect SMO 20 before insulation testing the house wiring.
- If the building is equipped with an earth-fault breaker, SMO 20 should be equipped with a separate one.
- SMO 20 must be installed via a circuit breaker with a minimum breaking gap of 3 mm.
- For the electrical wiring diagram for the control module, see page .51.
- Use a screened three core cable for communication with the heat pump.
- Communication and sensor cables to external connections must not be laid close to high current cables.
- The minimum area of communication and sensor cables to external connections must be 0.5 mm² up to 50 m, for example EKKX, LiYY or equivalent.
- When cable routing into SMO 20, cable grommets (UB1 and UB2, marked in image) must be used.



NOTE



The switch (SF1) must not be moved to "I" or "△" until the boiler in the system has been filled with water. The compressor in the heat pump and any external additional heat can be damaged.



NOTE



Electrical installation and service must be carried out under the supervision of a qualified electrician. Cut the current with the circuit breaker before carrying out any servicing. Electrical installation and wiring must be carried out in accordance with the stipulations in force.

When installing SMO 20, NIBE's air/water heat pump and any addition must be current free.



NOTE



See outline diagram for your system for physical location of the temperature sensor that is to be installed.

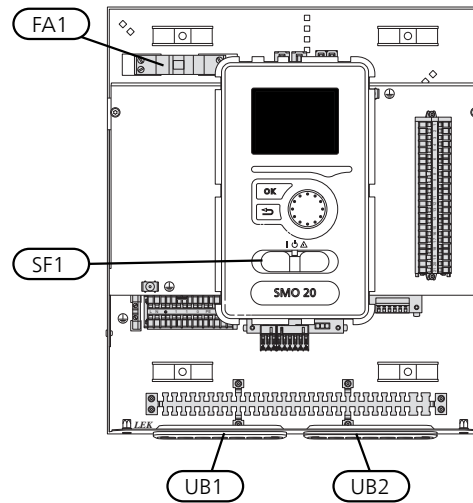

Miniature circuit-breaker

The control module operating circuit and parts of its internal components are internally fused by a miniature circuit breaker (FA1).

Accessibility, electrical connection

The cover of the control module is opened using a Torx 25 screwdriver. Assembly takes place in the reverse order.

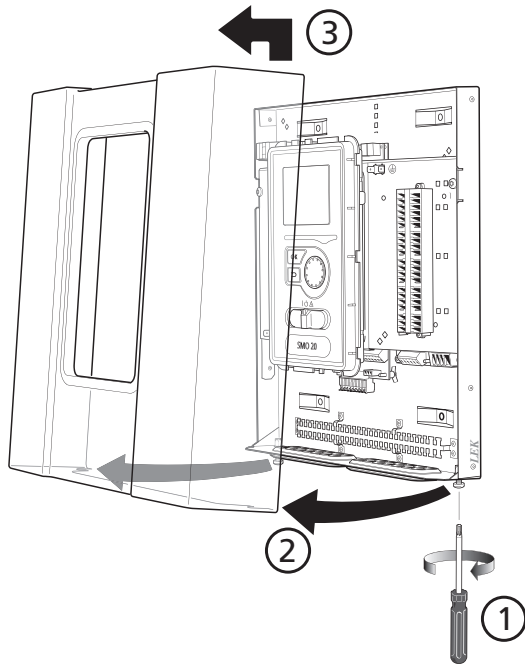

NOTE

The cover to access the base board is opened using a Torx 25 screwdriver.

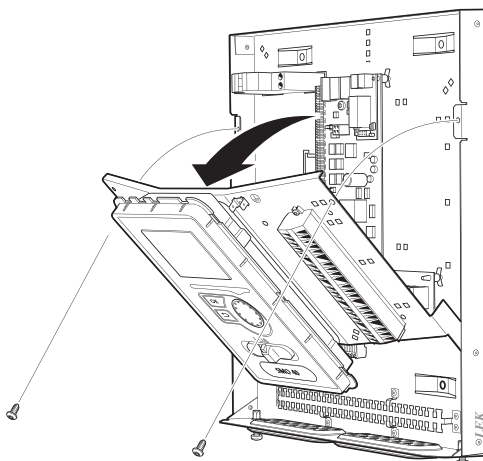

The display may need to be moved for easier access when connecting electrics. This is easily done by following these steps.

1.

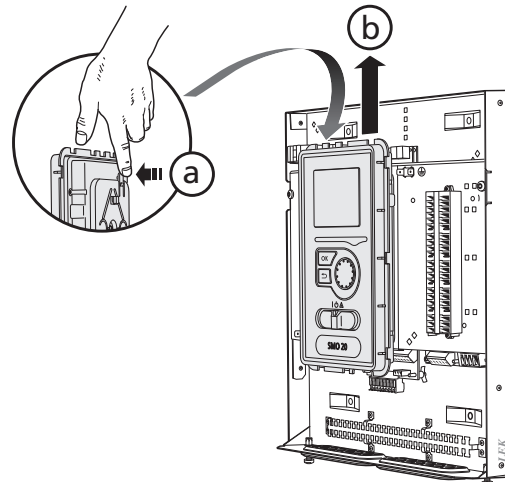

Press in the catch on the upper rear side of the display unit towards you (a) and move the display unit upwards (b) so that the mountings unhook from the panel.

2.

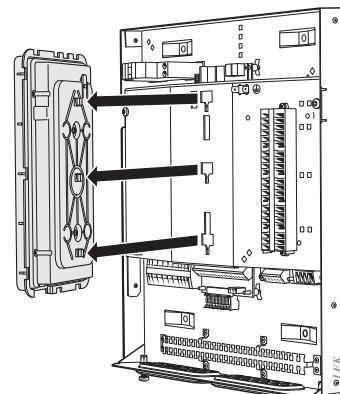

Lift the display unit from its mountings.

3.

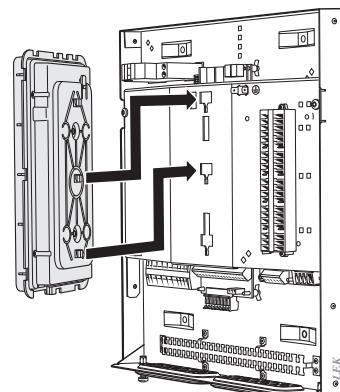

Align the two lower mountings on the reverse of the display unit with the two upper holes in the panel as illustrated.

4.

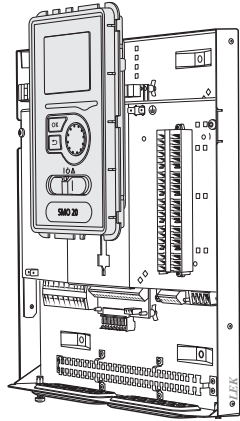

Secure the display on the panel.

5. When the electrical connection is ready the display must be reinstalled with three mounting points again, otherwise the front cover cannot be installed.

Cable lock

Use a suitable tool to release/lock cables in the heat pump terminal blocks.

Terminal block on the electrical card

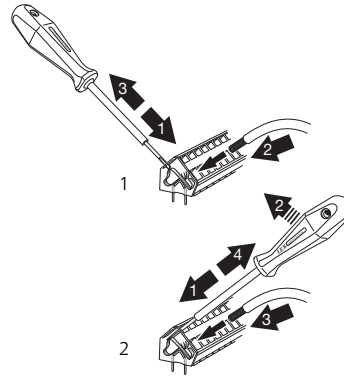

Terminal block

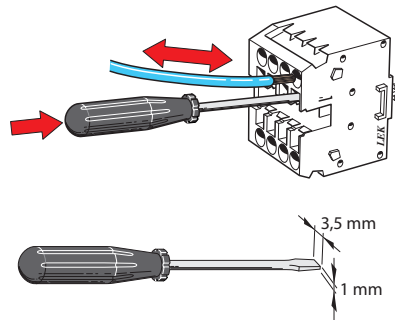

Connections

NOTE
To prevent interference, unshielded communication and/or sensor cables to external connections must not be laid closer than 20 cm from high voltage cables.

Power connection

SMO 20 must be installed via an isolator switch with a minimum breaking gap of 3mm. Minimum cable area must be sized according to the fuse rating used.

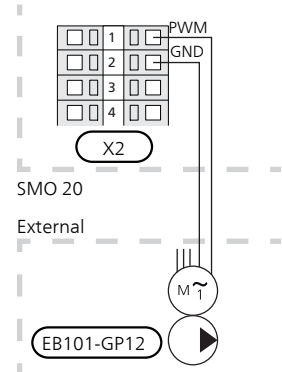
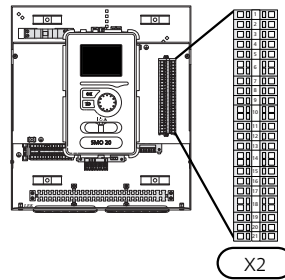
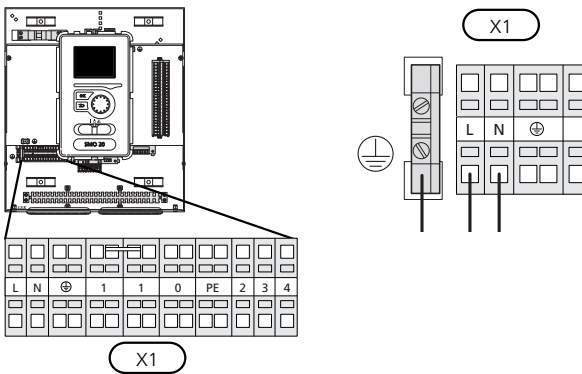

Tariff control

If the voltage to the compressor in the heat pump disappears for a certain period, simultaneous blocking of these must take place via software controlled input (AUX input) to avoid alarm, see page 23.

Connecting the charge pump for the heat pump

Connect circulation pump (EB101-GP12) to terminal block X4:5 (PE), X4:6 (N) and X4:7 (230 V) on the base board (AA2) as illustrated.

Connect control signal for (EB101-GP12) to terminal block X2:1 (PWM) and X2:2 (GND) as illustrated.

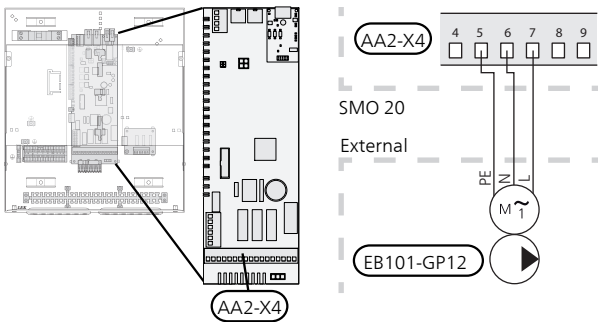

Communication with heat pump

Connect the heat pump (EB101) with a screened three core cable to terminal block X2:19 (A), X2:20 (B) and X2:21 (GND) as illustrated.

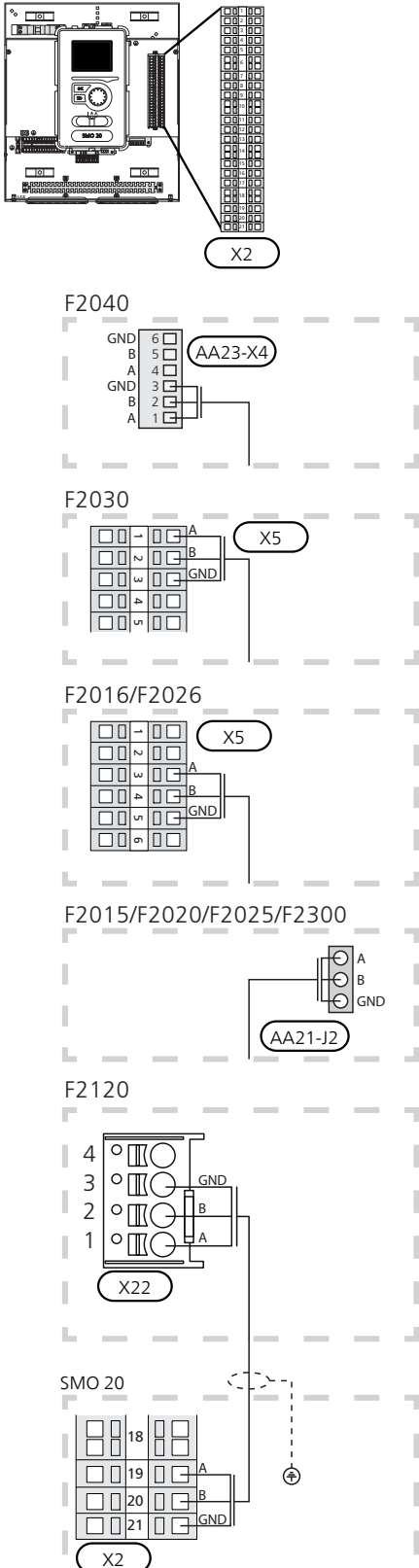

Outside sensor

Install the outdoor temperature sensor (BT1) in the shade on a wall facing north or north-west, so it is unaffected by the morning sun for example.

Connect the sensor to terminal block X2:3 and X2:6. Use a twin core cable with a cable area of at least 0.5 mm².

If a conduit is used it must be sealed to prevent condensation in the sensor capsule.

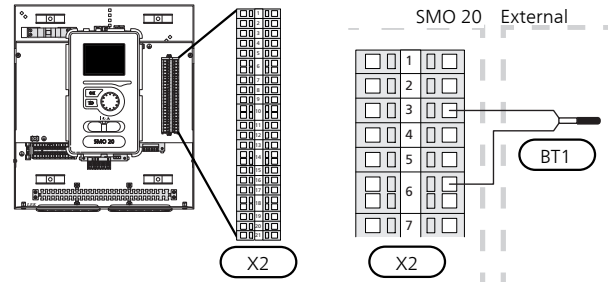

Temperature sensor, hot water charging

The temperature sensor, hot water charging (BT6) is placed in the submerged tube on the water heater.

Connect the sensor to terminal block X2:5 and X2:6. Use a twin core cable with a cable area of at least 0.5 mm².

Hot water charging is activated in menu 5.2 or in the start guide.

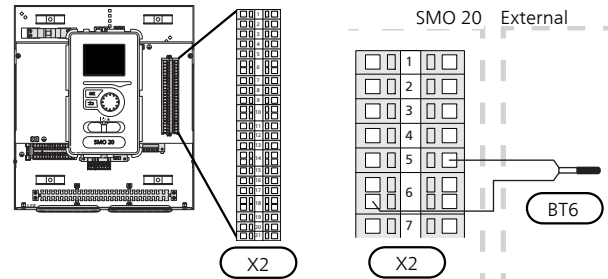

Temperature sensor, hot water top

A temperature sensor for hot water top (BT7) can be connected to SMO 20 to show the water temperature at the top of the tank (if it is possible to install a sensor at the top of the tank).

Connect the sensor to terminal block X2:4 and X2:6. Use a twin core cable with a cable area of at least 0.5 mm².

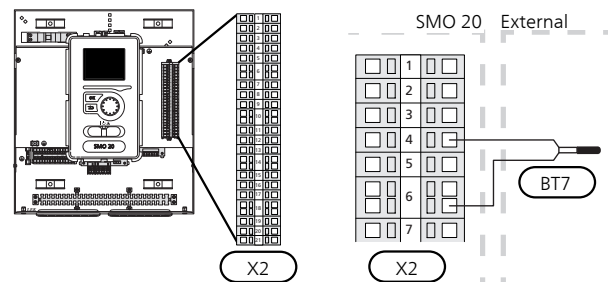

Temperature sensor, external flow line

Connect the temperature sensor, external supply line (BT25) (required for additional heat after reversing valve (QN10), to terminal block X2:8 and X2:10. Use a twin core cable with a cable area of at least 0.5 mm².

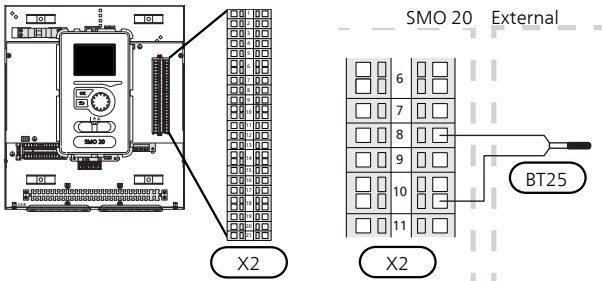

Temperature sensor, external supply at additional heat before reversing valve (QN10)

Connect the temperature sensor, external supply line (BT63) (required for additional heat before the reversing valve for hot water charging (QN10), to terminal block X2:9 and X2:10. Use a twin core cable with a cable area of at least 0.5 mm².

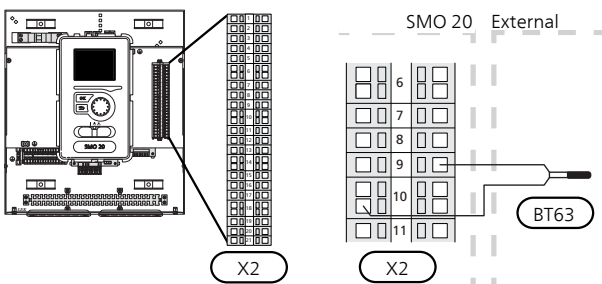

NOTE

For docking that requires connection of other sensors. See "Possible selection for AUX inputs" on page 23.

Optional connections

Room sensor

SMO 20 can be supplemented with a room sensor (BT50). The room sensor has a number of functions:

1. Shows current room temperature in the control module display.
2. Provides the option of changing the room temperature in °C.
3. Provides the option of fine-tuning the room temperature.

Install the sensor in a neutral position where the set temperature is required. A suitable location is on a free inner wall in a hall approx. 1.5 m above the floor. It is important that the sensor is not prevented from measuring the correct room temperature by being located, for example, in a recess, between shelves, behind a curtain, above or close to a heat source, in a draft from an external door or in direct sunlight. Closed radiator thermostats can also cause problems.

The control module operates without the sensor, but if you want to read off the home's indoor temperature in the control module's display, the sensor must be installed. Connect the room sensor to terminal block X2:7 and X2:10.

If the sensor is to be used to change the room temperature in °C and/or to fine-tune the room temperature, the sensor must be activated in menu 1.9.4.

If the room sensor is used in a room with underfloor heating, it should only have an indicative function, not control of the room temperature.

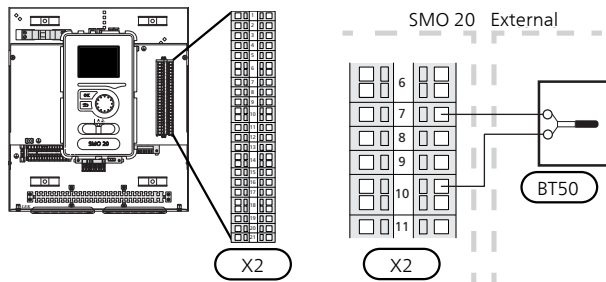

Caution

Changes of temperature in accommodation take time. For example, short time periods in combination with underfloor heating will not give a noticeable difference in room temperature.

Step controlled additional heat

NOTE

Mark up any junction boxes with warnings for external voltage.

External step controlled additional heat can be controlled by up to three potential-free relays in the control module (3 step linear or 7 step binary). Alternatively two relays (2 step linear or 3 step binary) can be used for step controlled additional heat, which means that the third relay can be used to control the immersion heater in the water heater/accumulator tank.

Step in occurs with at least 1 minute interval and step outs with at least 3 seconds interval.

Step 1 is connected to terminal block X2:2 on the additional relay board (AA7).

Step 2 is connected to terminal block X2:4 on the additional relay board (AA7).

Step 3 or immersion heater in the water heater/accumulator tank is connected to terminal block X2:6 on the additional relay board (AA7).

The settings for step controlled additional heat are made in menu 4.9.3 and menu 5.1.12.

All additional heat can be blocked by connecting a potential-free switch function to the software controlled input on terminal block X2 (see page 23) which is selected in menu 5.4.

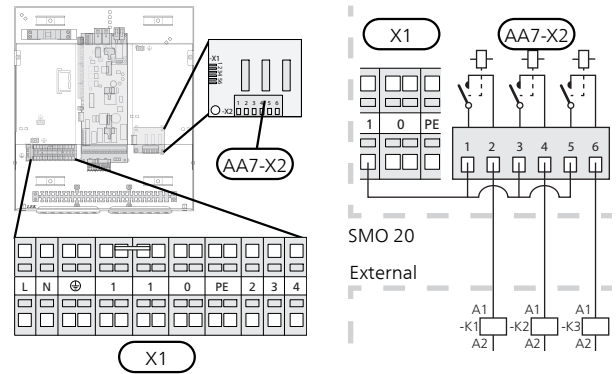

If the relays are to be used for control voltage, bridge the supply from terminal block X1:1 to X2:1, X2:3 and X2:5 on additional relay board (AA7). Connect the neutral from the external additional heat to terminal block X1:0.

With step controlled additional heat before the reversing valve

The electric additional heat will charge with the maximum permitted immersion heater output together with the compressor to conclude the hot water charging and return to charging the heating as soon as possible. This only occurs when the number of degree minutes is below the start value for the additional heat.

Relay output for emergency mode



NOTE

Mark up any junction boxes with warnings for external voltage.

When the switch (SF1) is in "Δ" mode (emergency mode) the circulation pump is activated (EB101-GP12).



Caution

No hot water is produced when emergency mode is activated.

The emergency mode relay can be used to activate external additional heat, an external thermostat must then be connected to the control circuit to control the temperature. Ensure that the heating medium circulates through the external additional heating.

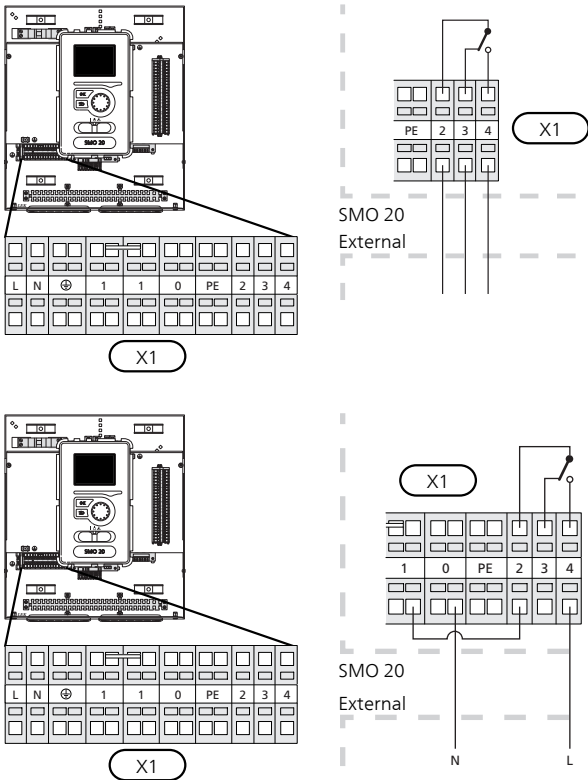

If the relay is to be used for control voltage, bridge the supply from terminal block X1:1 to X1:2 and connect neutral and control voltage from the external additional heat to X1:0 (N) and X1:4 (L).

External circulation pump

Connect the external circulation pump (GP10) to terminal block X4:9 (PE), X4:10 (N) and X4:11 (230 V) on the base board (AA2) as illustrated.

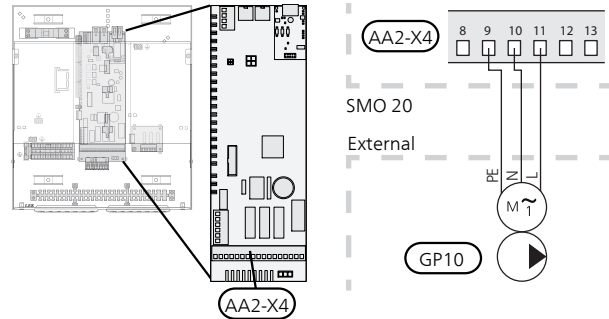

Shuttle valve

SMO 20 can be supplemented with an external reversing valve (QN10) for hot water control. (See page 46 for accessory)

Hot water production can be selected in menu 5.2.4.

Connect the external reversing valve (QN10) as illustrated to terminal block X4:2 (N), X4:3 (control) and X4:4 (L) on the base board (AA2).

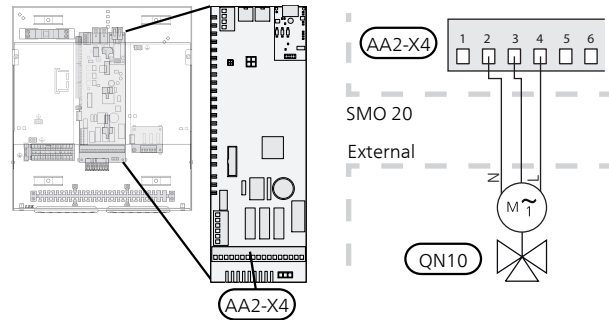

NIBE Uplink

Connect the network connected cable (straight, Cat.5e UTP) with RJ45 contact (male) to contact AA4-X9 on the display unit (as illustrated). Use the cable grommet (UB2) in the control module for cable routing.

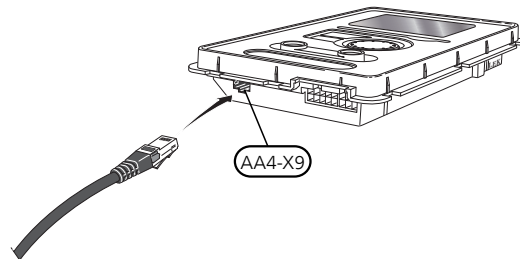

External connection options

On terminal block X2, SMO 20 has software controlled inputs and outputs for connection of sensors and external switch function. This means that a sensor or an external switch function can be connected to one of six special connections where the function for connection is determined in the control module software.



Caution

If an external switch contact function is connected to SMO 20, the function for use input or output must be selected in menu 5.4.

Selectable inputs terminal block X2 for these functions are AUX1 (X2:11), AUX2 (X2:12), AUX3 (X2:13), AUX4 (X2:15), AUX5 (X2:16) and AUX6 (X2:17). Earth is connected to terminal block X2:14 or X2:18 (see electrical wiring diagram for more information).

Selectable output is terminal block X4:15-17 on the base board (AA2).

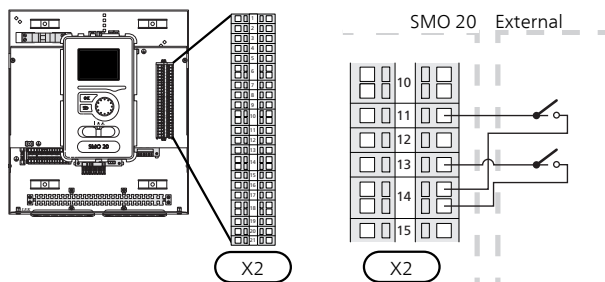
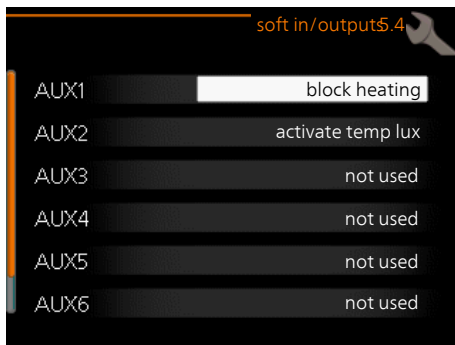

The example above uses the inputs AUX1 (X2:11) and AUX3 (X2:13) on terminal block X2.



Caution

Some of the following functions can also be activated and scheduled via menu settings.

Possible selection for AUX inputs

Following functions can be connected to the AUX inputs on terminal block X2.

These functions are then selected in menu 5.4. Use a twin core cable with a cable area of at least 0.5 mm².

Temperature sensor, cooling/heating

If a particular room will determine how the whole installation will work, a room sensor ((BT74) is used. If room sensor (BT74) is connected to SMO 20, room

sensor (BT74) determines when it is time to switch between cooling and heating operation for the whole installation.

The alternative only applies if accessories for cooling are present or if the heat pump has the integrated cooling function.

Temperature sensor, external return line

If temperature sensor, external return line (BT71) needs to be used, connect it to selected input (menu 5.4, see page 38) on terminal block X2. Use a 2 core cable with a cable area of at least 0.5 mm².

Temperature sensor, flow line cooling

In cases where the active cooling in a 4-pipe system function is used on the AUX output, a temperature sensor supply line cooling (BT64) must be connected to SMO 20. This option is only shown if the cooling function in the heat pump has been activated.

Contact for external tariff blocking

In cases where external tariff blocking is required it must be connected to terminal block X2.

Tariff blocking means that the additional heat, the compressor, heating and cooling are disconnected by connecting a potential-free switch function to the input selected in menu 5.4.

A closed contact results in the electrical output being disconnected.

Switch for "SG ready"



NOTE

This function can only be used in mains networks that support the "SG Ready"-standard . "SG Ready" requires two AUX inputs.

In cases where this function is wanted it must be connected to terminal block X2.

"SG Ready" is a smart form of tariff control where your electricity supplier can affect the indoor and hot water temperatures or simply block the additional heat and/or the compressor in the heat pump at certain times of the day (can be selected in menu 4.1.5 after the function is activated). Activate the function by connecting potential-free switch functions to two inputs selected in menu 5.4 (SG Ready A and SG Ready B), see page 38.

Closed or open switch means one of the following:

– Blocking (A: Closed, B: Open)

"SG Ready" is active. The compressor in the heat pump and additional heat is blocked like the day's tariff blocking.

– Normal mode (A: Open, B: Open)

"SG Ready" is not active. No effect on the system.

– Low price mode (A: Open, B: Closed)

"SG Ready" is active. The system focuses on costs savings and can for example exploit a low tariff from the electricity supplier or over-capacity from any own power source (effect on the system can be adjusted in the menu 4.1.5).

– **Overcapacity mode (A: Closed, B: Closed)**

"SG Ready" is active. The system is permitted to run at full capacity at over capacity (very low price) with the electricity supplier (effect on the system is settable in menu 4.1.5).

(A = SG Ready A and B = SG Ready B)

■ **Contact for activation of "luxury"**

An external switch function can be connected to SMO 20 to activate the hot water function "luxury". The switch must be potential-free and connected to the selected input (menu 5.4) on terminal block X2.

"luxury" is activated for the time that the contact is connected.

■ **Contact for activation of "external adjustment"**

An external contact function can be connected to SMO 20 to change the supply temperature and the room temperature.

When the switch is closed the temperature changes in °C (if the room sensor is connected and activated). If a room sensor is not connected or not activated the desired change of "temperature" (heating curve offset) with the number of steps selected is set. The value can be set between -10 and +10 .

– *climate system 1*

The switch must be potential-free and connected to the selected input (menu 5.4) on terminal block X2.

The value for the change is set in menu 1.9.2, "external adjustment".

■ **Switch for external alarm**

Alarms from external devices can be connected to the control and appear as an info alarm. Potential-free signal of NO or NC type can be connected.

Switch for external blocking of

In those cases where external blocking of the function is desired, this can be connected to terminal block X2.

The function is disconnected by connecting a potential-free switch function to the input selected in menu 5.4.

A closed contact results in the function being disconnected.

Functions that can be blocked:

- addition
- compressor in heat pump EB101
- heating
- cooling
- hot water

Possible selection for AUX output (potential free variable relay)

It is possible to have an external connection through the relay function via a potential-free switching relay (max. 2 A at resistive load) on terminal block X4:15-17 on the base board (AA2).

Optional functions for external connection:

- Indication of buzzer alarm. The function gives signals whilst a constant alarm is indicated by the control module.
- Cooling mode indication. This option requires activation of some form of cooling function. The function gives signals when the system permits cooling and can be used to control external pumps for example.
- Active cooling (4 pipe). This option requires activation of some form of cooling function and can be used for simple 4-pipe systems (an outdoor unit). The function issues signals when a connected heat pump is producing cooling and there are no other demands and cooling is permitted. This function can be used to control reversing valve for cooling EP25-QN12.



Caution

With this option, the charge pump (GP12) is always controlled in "auto" operating mode, which means that the pump is running when the reversing valve (QN12) is towards the cooling system.

- External heating medium pump. The function gives signals when an external circulation pump (GP10) is to be operated according to settings for the operating mode.
- Control of circulation pump for hot water circulation. The function gives signals when a circulation pump for hot water circulation (GP11) is to be operated according to settings in menu "hot water recirc." (2.9.2).
- Holiday indication.
- Wood docking. This option is based on docking for an existing wood-fired installation with automatic shunt that is supplemented with air/water heat pump. The output controls the existing system pump (GP15) that is started when the wood-fired system is running. For more information, see www.nibe.eu.

If any of the above is connected to terminal block X4:15-17 on the base board (AA2), the function must be selected in menu 5.4.

The common alarm is preselected at the factory.

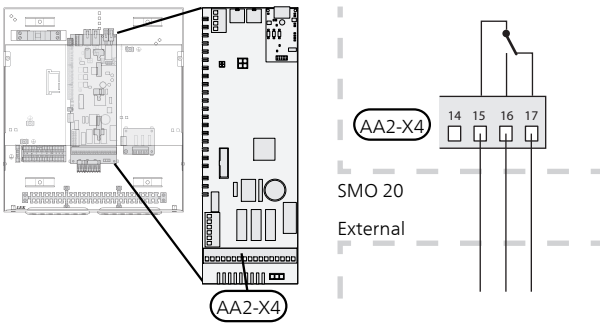

The picture shows the relay in the alarm position.
 When switch (SF1) is in the "U" or "Δ" position the relay is in the alarm position.

Hot water circulation pump or external heating medium pump is connected to the AUX output, as illustrated below.

NOTE
 Mark up any junction boxes with warnings for external voltage.

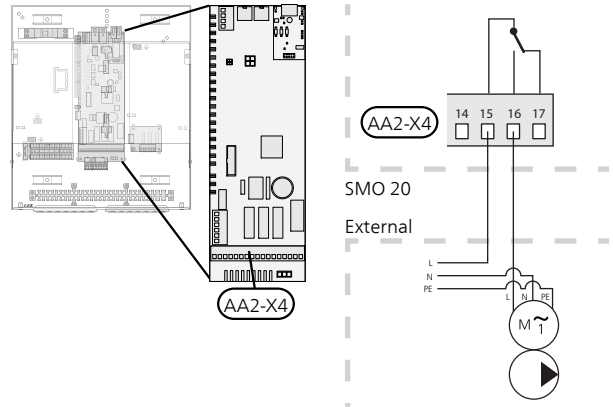

The reversing valve for cooling is connected to the AUX output, as illustrated below.

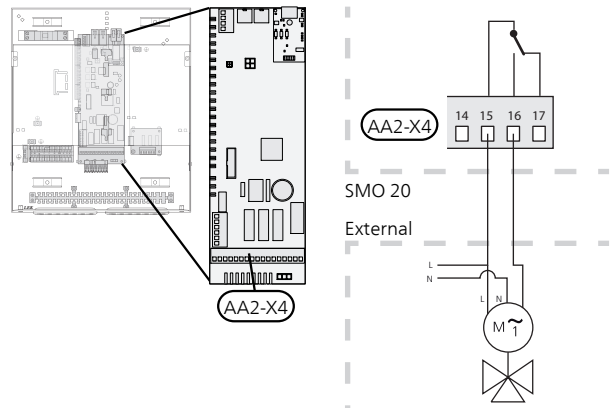

Caution
 The relay outputs may be subjected to a max load of 2 A at resistive load (230V AC).

Connecting accessories

Instructions for connecting other accessories are in the installation instructions provided. See page 46 for a list of those accessories that can be used for SMO 20.

6 Commissioning and adjusting

Preparations

- Compatible NIBE air/water heat pump must be equipped with a control board that has at least the software version as listed on page 9. The control board version is displayed in the heat pump's display (if applicable) at start-up.
- SMO 20 must be ready-connected.
- The climate system must be filled with water and bled.

Commissioning with NIBE air/water heat pump

NIBE F2015 / F2020 / F2025

- Follow the instructions in the heat pump's Installation and Maintenance under section "Commissioning and adjustment" – "Start-up and inspection".

NIBE F2016 / F2026 / F2030 / F2040 / F2120 / F2300

- Follow the instructions in the heat pump's Installer Manual under section "Commissioning and adjustment" – "Start-up and inspection".

SMO 20

1. Power the heat pump.
2. Power SMO 20.
3. Follow the start guide in the display on SMO 20 alternatively start the start guide in menu 5.7.

Commissioning with additional heating only

At first start follow the start guide, otherwise follow the list below.

1. Go to menu 4.2 op. mode.
2. Mark "add. heat only" using the control knob and then press the OK button.
3. Return to the main menus by pressing the Back button.



Caution

When commissioning without NIBE air/water heat pump, the communication error alarm may appear in the display.

The alarm is reset if the relevant heat pump is deactivated in menu 5.2.2 ("installed heat pump").

Check the reversing valve

1. Activate "AA2-K1 (QN10)" in menu 5.6.
2. Check that the reversing valve opens or is open for hot water charging.
3. Deactivate "AA2-K1 (QN10)" in menu 5.6.

Check AUX socket

To check any function connected to the AUX socket

1. Activate "AA2-X4" in menu 5.6.
2. Check the desired function.
3. Deactivate "AA2-X4" in menu 5.6.

Cooling mode

If the installation contains a NIBE air/water heat pump that can produce cooling (NIBE F2040 or F2120), cooling operation can be permitted. See relevant Installer Manual.

When cooling operation is permitted you can choose cooling mode indication in menu 5.4 for the AUX output.

Start guide



NOTE

There must be water in the climate system before the switch is set to "I".

1. Set switch (SF1) on SMO 20 to position "I".
2. Follow the instructions in the display's start guide. If the start guide does not start when you start the SMO 20, start it manually in menu 5.7.



TIP

See page 29 for a more in-depth introduction to the installation's control system (operation, menus etc.).

Commissioning

The first time the installation is started a start guide is started. The start guide instructions state what needs to be carried out at the first start together with a run through of the installation's basic settings.

The start guide ensures that start-up is carried out correctly and cannot be bypassed. The start guide can be started later in menu 5.7.

During the start-up guide, the reversing valves and the shunt are run back and forth to help vent the heat pump.



Caution

As long as the start guide is active, no function in SMO 20 will start automatically.

The guide will appear at each restart of SMO 20, until it is deselected on the last page.

Operation in the start guide

A. Page

B. Name and menu number

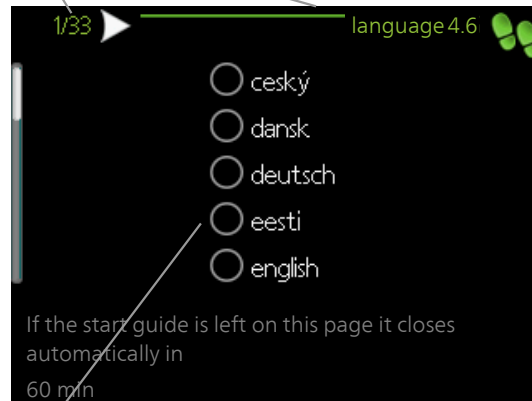

C. Option / setting

A. Page

Here you can see how far you have come in the start guide.

Scroll between the pages of the start guide as follows:

1. Turn the control knob until one of the arrows in the top left corner (at the page number) has been marked.
2. Press the OK button to skip between the pages in the start guide.

B. Name and menu number

Read what menu in the control system this page of the start guide is based on. The digits in brackets refer to the menu number in the control system.

If you want to read more about affected menus either consult the help menu or read the user manual.

C. Option / setting

Make settings for the system here.

D. Help menu



In many menus there is a symbol that indicates that extra help is available.

To access the help text:

1. Use the control knob to select the help symbol.
2. Press the OK button.

The help text often consists of several windows that you can scroll between using the control knob.

7 Control - Introduction

Display unit

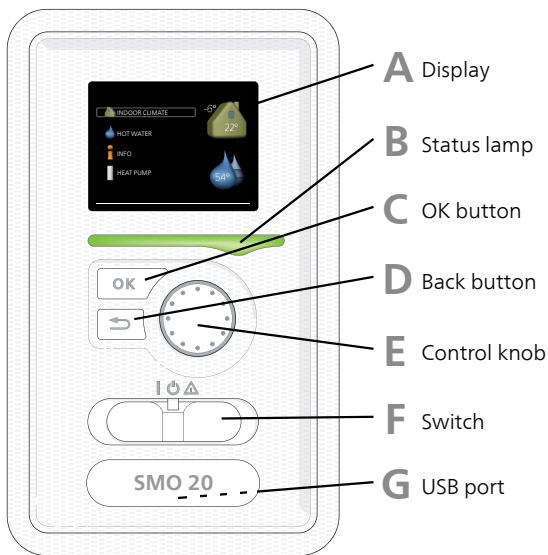

A Display

Instructions, settings and operational information are shown on the display. You can easily navigate between the different menus and options to set the comfort or obtain the information you require.

B Status lamp

The status lamp indicates the status of the control module. It:

- lights green during normal operation.
- lights yellow in emergency mode.
- lights red in the event of a deployed alarm.

C OK button

The OK button is used to:

- confirm selections of sub menus/options/set values/page in the start guide.

D Back button

The back button is used to:

- go back to the previous menu.
- change a setting that has not been confirmed.

E Control knob

The control knob can be turned to the right or left. You can:

- scroll in menus and between options.
- increase and decrease the values.
- change page in multiple page instructions (for example help text and service info).

F Switch (SF1)

The switch assumes three positions:

- On (I)
- Standby (⏻)
- Emergency mode (⚠)

Emergency mode must only be used in the event of a fault on the control module. In this mode, the compressor in the heat pump switches off and the immersion heater engages. The control module display is not illuminated and the status lamp illuminates yellow.

G USB port

The USB port is hidden beneath the plastic badge with the product name on it.

The USB port is used to update the software.

Visit <http://www.nibeuplink.com> and click the "Software" tab to download the latest software for your installation.

Menu system

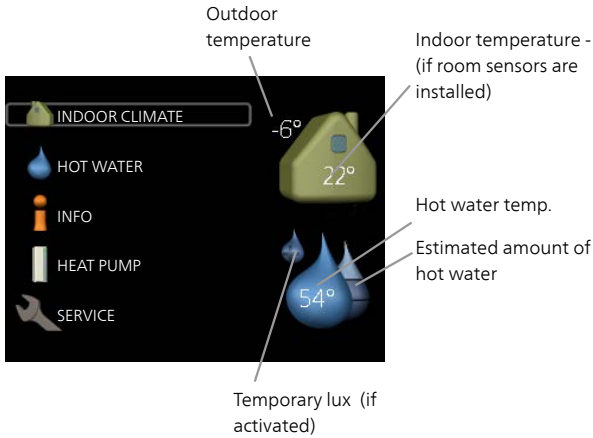

Menu 1 - INDOOR CLIMATE

Setting and scheduling the indoor climate. See information in the help menu or user manual.

Menu 2 - HOT WATER

Setting and scheduling hot water production. See information in the help menu or user manual.

This menu only appears if a water heater is installed in the system.

Menu 3 - INFO

Display of temperature and other operating information and access to the alarm log. See information in the help menu or user manual.

Menu 4 - MY SYSTEM

Setting time, date, language, display, operating mode etc. See information in the help menu or user manual.

Menu 5 - SERVICE

Advanced settings. These settings are not available to the end user. The menu is visible when the Back button is pressed for 7 seconds, when you are in the start menu. See page 36.

Symbols in the display

The following symbols can appear in the display during operation.

Symbol	Description
	This symbol appears by the information sign if there is information in menu 3.1 that you should note.
	These two symbols indicate whether the compressor in the outdoor unit or additional heat in the installation is blocked via SMO 20. These can, for example, be blocked depending on which operating mode is selected in menu 4.2, if blocking is scheduled in menu 4.9.5 or if an alarm has occurred that blocks one of them.
	Blocking the compressor.
	Blocking additional heat.
	This symbol appears if periodic increase or lux mode for the hot water is activated.
	This symbol indicates whether "holiday setting" is active in 4.7.
	This symbol indicates whether SMO 20 has contact with Uplink.
	This symbol indicates whether solar heating is active. Accessory needed.
	This symbol indicates whether cooling is active. Heat pump with cooling function required.

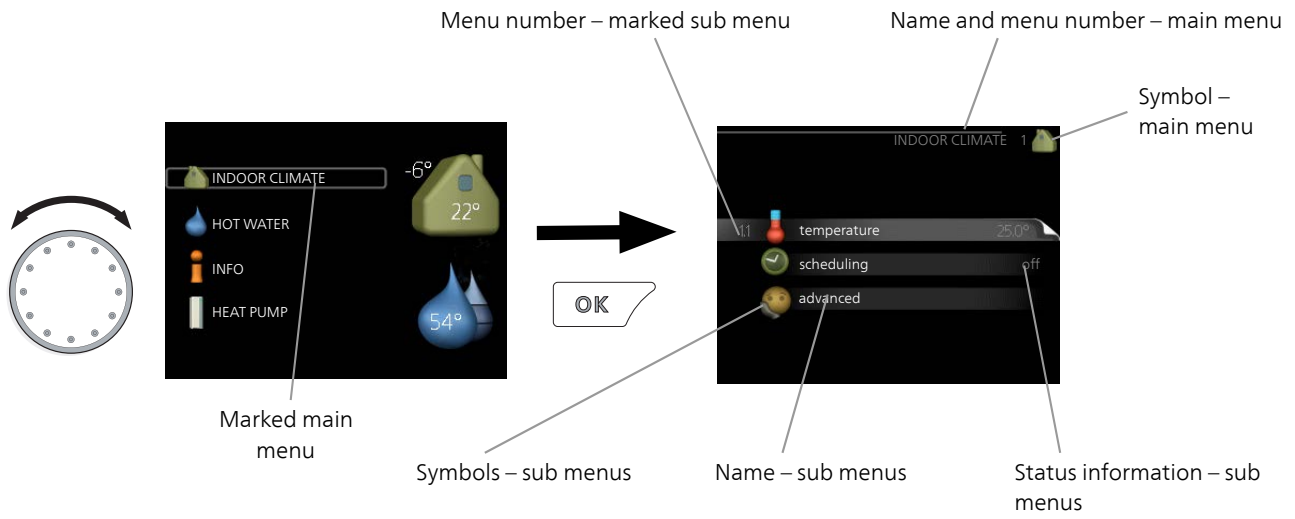

Operation

To move the cursor, turn the control knob to the left or the right. The marked position is brighter and/or has a light frame.





Selecting menu

To advance in the menu system select a main menu by marking it and then pressing the OK button. A new window then opens with sub menus.

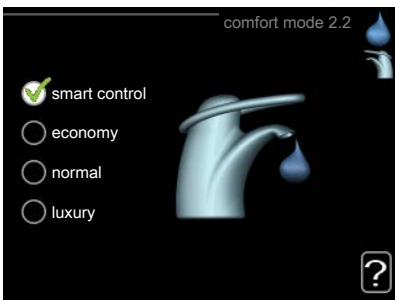

Select one of the sub menus by marking it and then pressing the OK button.

Selecting options



In an options menu the current selected option is indicated by a green tick. 

To select another option:





1. Mark the applicable option. One of the options is pre-selected (white). 
2. Press the OK button to confirm the selected option. The selected option has a green tick. 

Setting a value



Values to be changed

To set a value:

1. Mark the value you want to set using the control knob. 
2. Press the OK button. The background of the value becomes green, which means that you have accessed the setting mode. 
3. Turn the control knob to the right to increase the value and to the left to reduce the value. 
4. Press the OK button to confirm the value you have set. To change and return to the original value, press the Back button. 

Use the virtual keyboard

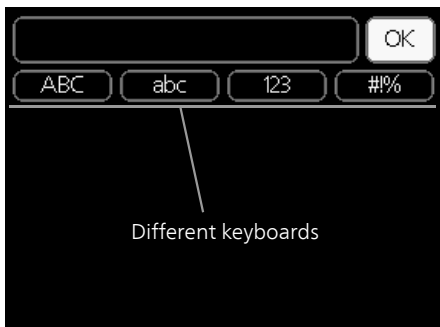

In some menus where text may require entering, a virtual keyboard is available.



Depending on the menu, you can gain access to different character sets which you can select using the control knob. To change character table, press the Back button. If a menu only has one character set the keyboard is displayed directly.

When you have finished writing, mark "OK" and press the OK button.

Scroll through the windows

A menu can consist of several windows. Turn the control knob to scroll between the windows.



Current menu window Number of windows in the menu

Scroll through the windows in the start guide



Arrows to scroll through window in start guide

1. Turn the control knob until one of the arrows in the top left corner (at the page number) has been marked.
2. Press the OK button to skip between the steps in the start guide.

Help menu



In many menus there is a symbol that indicates that extra help is available.

To access the help text:

1. Use the control knob to select the help symbol.
2. Press the OK button.

The help text often consists of several windows that you can scroll between using the control knob.

8 Control

Menu 1 - INDOOR CLIMATE

1 - INDOOR CLIMATE	1.1 - temperature	1.1.1 - heating	
		1.1.2 - cooling *	
	1.3 - scheduling	1.3.1 - heating	
		1.3.2 - cooling *	
	1.9 - advanced	1.9.1 - curve	1.9.1.1 heating curve
			1.9.1.2 - cooling curve *
		1.9.2 - external adjustment	
		1.9.3 - min. flow line temp.	1.9.3.1 - heating
			1.9.3.2 - cooling *
		1.9.4 - room sensor settings	
		1.9.5 - cooling settings *	
		1.9.7 - own curve	1.9.7.1 - heating
			1.9.7.2 - cooling *
		1.9.8 - point offset	

* Heat pump with cooling function required.

Menu 2 - HOT WATER

2 - HOT WATER	2.1 - temporary lux	
	2.2 - comfort mode	
	2.3 - scheduling	
	2.9 - advanced	2.9.1 - periodic increase
		2.9.2 - hot water recirc. *

Menu 3 - INFO

3 - INFO	3.1 - service info	
	3.2 - compressor info	
	3.3 - add. heat info	
	3.4 - alarm log	
	3.5 - indoor temp. log	

* Accessories are needed.

Menu 4 - MY SYSTEM

4 - MY SYSTEM	4.1 - plus functions	4.1.3 - internet	4.1.3.1 - Uplink
			4.1.3.8 - tcp/ip settings
			4.1.3.9 - proxy settings
		4.1.5 - SG Ready	
		4.1.6 - smart price adaption™	
		4.1.7 - smart home	
		Menu 4.1.10 – solar electricity *	
	4.2 - op. mode		
	4.4 - time & date		
	4.6 - language		
	4.7 - holiday setting		
	4.9 - advanced	4.9.1 - op. prioritisation	
		4.9.2 - auto mode setting	
		4.9.3 - degree minute setting	
		4.9.4 - factory setting user	
		4.9.5 - schedule blocking	
		4.9.6 - schedule silent mode	

Menu 5 - SERVICE

Overview

5 - SERVICE	5.1 - operating settings	5.1.1 - hot water settings *
		5.1.2 - max flow line temperature
		5.1.3 - max diff flow line temp.
		5.1.4 - alarm actions
		*
		5.1.12 - addition
		5.1.14 - flow set. climate system
		5.1.22 - heat pump testing
		5.1.23 - compressor curve
	5.2 - system settings	5.2.2 - installed heat pump
		5.2.4 - accessories
	5.4 - soft in/outputs	
	5.5 - factory setting service	
	5.6 - forced control	
	5.7 - start guide	
	5.8 - quick start	
	5.9 - floor drying function	
	5.10 - change log	
	5.11 - heat pump settings	5.11.1.1 - heat pump
		5.11.1.2 - charge pump (GP12)
	5.12 - country	

* Accessory needed.

Go to the main menu and hold the Back button in for 7 seconds to access the Service menu.

Sub-menus

Menu **SERVICE** has orange text and is intended for the advanced user. This menu has several sub-menus. Status information for the relevant menu can be found on the display to the right of the menus.

operating settings Operating settings for the control module.

system settings System settings for the control module, activating accessories etc.

soft in/outputs Setting software-controlled inputs and outputs on terminal block (X2).

factory setting service Total reset of all settings (including settings available to the user) to default values.

forced control Forced control of the different components in the indoor module.

start guide Manual start of the start guide which is run the first time when the control module is started.

quick start Quick starting the compressor.



NOTE

Incorrect settings in the service menus can damage the installation.

Menu 5.1 - operating settings

Operating settings can be made for the control module in the sub menus.

Menu 5.1.1 - hot water settings

economy

Setting range start temp. economy: 5 – 55 °C

Factory setting start temp. economy: 42 °C

Setting range stop temp. economy: 5 – 60 °C

Factory setting stop temp. economy: 48 °C

normal

Setting range start temp. normal: 5 – 60 °C

Factory setting start temp. normal: 46 °C

Setting range stop temp. normal: 5 – 65 °C

Factory setting stop temp. normal: 50 °C

luxury

Setting range start temp. lux: 5 – 70 °C

Factory setting start temp. lux: 49 °C

Setting range stop temp. lux: 5 – 70 °C

Factory setting stop temp. lux: 53 °C

stop temp. per. increase

Setting range: 55 – 70 °C

Factory setting: 55 °C

charge method

Setting range: target temp, delta temp

Default value: delta temp

Here you set the start and stop temperature of the hot water for the different comfort options in menu 2.2 as well as the stop temperature for periodic increase in menu 2.9.1.

The charge method for hot water operation is selected here. "delta temp" is recommended for heaters with charge coil, "target temp" for double-jacketed heaters and heaters with hot water coil.

Menu 5.1.2 - max flow line temperature

climate system

Setting range: 5-70 °C

Default value: 60 °C

Set the maximum supply temperature for the climate system here.



Caution

Underfloor heating systems are normally **max flow line temperature** set between 35 and 45 °C.

Check the max floor temperature with your floor supplier.

Menu 5.1.3 - max diff flow line temp.

max diff compressor

Setting range: 1 – 25 °C

Default value: 10 °C

max diff addition

Setting range: 1 – 24 °C

Default value: 7 °C

Here you set the maximum permitted difference between the calculated and actual supply temperature during compressor respectively add. heat mode. Max diff. additional heat can never exceed max diff. compressor

max diff compressor

If the current supply temperature **exceeds** the calculated flow with set value, the degree minute value is set to 0. The compressor in the heat pump stops when there is only a heating demand.

max diff addition

If "addition" is selected and activated in menu 4.2 and the present supply temp **exceeds** the calculated with set value, the additional heat is forced to stop.

Menu 5.1.4 - alarm actions

Select how you want the control module to alert you that there is an alarm in the display here. The different alternatives are; the heat pump stops producing hot water and/or reduces the room temperature.



Caution

If no alarm action is selected, it can result in higher energy consumption in the event of an alarm.

Menu 5.1.12 - addition

max step

Setting range (binary stepping deactivated): 0 – 3

Setting range (binary stepping activated): 0 – 7

Default value: 3

fuse size

Setting range: 1 - 200 A

Factory setting: 16 A

Here you select whether the step controlled additional heat is positioned before or after the reversing valve for hot water charging (QN10). Step controlled additional heat is for example an external electric boiler.

Here you can set the max permitted number of additional heat steps and binary or linear stepping. When binary stepping is deactivated (off), the settings refer to linear stepping.

If accessory hot water is available and additional heat location is selected to "after QN10" the number of steps are restricted to 2 steps linear or 3 steps binary. Output AA7-X2:6 is reserved in this mode for additional heat in the hot water tank.

You can also set the fuse size.



TIP

See the accessory installation instructions for function description.

Menu 5.1.14 - flow set. climate system

presettings

Setting range: radiator, floor heat., rad. + floor heat., DOT °C

Default value: radiator

Setting range DOT: -40.0 – 20.0 °C

The factory setting of DOT value depends on the country that has been given for the product's location. The example below refers to Sweden.

Factory setting DOT: -20.0 °C

own setting

Setting range dT at DOT: 0.0 – 25.0

Factory setting dT at DOT: 10.0

Setting range DOT: -40.0 – 20.0 °C

Factory setting DOT: -20.0 °C

The type of heating distribution system the heating medium pump works towards is set here.

dT at DOT is the difference in degrees between flow and return temperatures at dimensioned outdoor temperature.

Menu 5.1.22 - heat pump testing



NOTE

This menu is intended for testing SMO 20 according to different standards.

Use of this menu for other reasons may result in your installation not functioning as intended.

This menu contains several sub-menus, one for each standard.

Menu 5.1.23 - compressor curve



NOTE

This menu is only displayed if SMO 20 is connected to a heat pump with inverter controlled compressor.

Set whether the compressor in the heat pump should work to a particular curve under specific requirements or if it should work to predefined curves.

You set a curve for a demand (heat, hot water, cooling etc.) by unticking "auto", turning the control knob until a temperature is marked and pressing OK. You can now set at what temperature max- respectively min frequencies will occur.

This menu can consist of several windows (one for each available demand), use the navigation arrows in the top left corner to change between the windows.

Menu 5.2 - system settings

Make different system settings for your installation here, e.g. activate the connected heat pump and which accessories are installed.

Menu 5.2.2 - installed heat pump

If a heat pump is connected to the master installation, set it here.

Menu 5.2.4 - accessories

Set which accessories are installed on the installation here.

If the water heater is connected to SMO 20 hot water charging must be activated here.

Menu 5.4 - soft in/outputs

Here you can select to which in/output on the terminal block (X2) external switch function (page 23) must be connected.

Selectable inputs on terminal blocks AUX1-6 (X2:11-18 and output AA2-X4).

Menu 5.5 - factory setting service

All settings can be reset (including settings available to the user) to default values here.



NOTE

When resetting, the start guide is displayed the next time the control module is restarted.

Menu 5.6 - forced control

You can force control the different components in the control module and any connected accessories here.

Menu 5.7 - start guide

When the control module is started for the first time the start guide starts automatically. Start it manually here.

See page 28 for more information about the start guide.

Menu 5.8 - quick start

It is possible to start the compressor from here.



Caution

There must be a heating or hot water demand to start the compressor.



Caution

Do not quick start the compressor too many times over a short period of time as this may damage the compressor and its surrounding equipment.

Menu 5.9 - floor drying function

length of period 1 – 7

Setting range: 0 – 30 days

Factory setting, period 1 – 3, 5 – 7: 2 days

Factory setting, period 4: 3 days

temp. period 1 – 7

Setting range: 15 – 70 °C

Default value:

temp. period 1	20 °C
temp. period 2	30 °C
temp. period 3	40 °C
temp. period 4	45 °C
temp. period 5	40 °C
temp. period 6	30 °C
temp. period 7	20 °C

Set the function for under floor drying here.

You can set up to seven period times with different calculated flow temperatures. If less than seven periods are to be used, set the remaining period times to 0 days.

Mark the active window to activate the underfloor drying function. A counter at the bottom shows the number of days the function has been active.



TIP

If operating mode "add. heat only" is to be used, select it in menu 4.2.

Menu 5.10 - change log

Read off any previous changes to the control system here.

The date, time and ID no. (unique to certain settings) and the new set value is shown for every change.



NOTE

The change log is saved at restart and remains unchanged after factory setting.

Menu 5.11 - heat pump settings

Settings for installed heat pump can be made in the submenu.

Menu 5.11.1.1 - heat pump

Make settings for the installed heat pump here. To see what settings you can make, see installation manual for the heat pump.

Menu 5.11.1.2 - charge pump (GP12)

op. mode

Heating/cooling

Setting range: auto / intermittent

Default value: auto

Set the operating mode for the charge pump here.

auto: The charge pump runs according to the current operating mode for SMO 20.

intermittent: The charge pump starts and stops 20 seconds before and after the compressor in the heat pump.

speed during operation

heating, hot water, cooling

Setting range: auto / manual

Default value: auto

Manual setting

Setting range: 1–100 %

Default values: 70 %

speed in wait mode

Setting range: 1–100 %

Default values: 30 %

max. allowed speed

Setting range: 80–100 %

Default values: 100 %

Set the speed at which the charge pump is to operate in the present operating mode. Select "auto" if the speed of the charge pump is to be regulated automatically (factory setting) for optimal operation.

If "auto" is activated for heating operation, you can also make the setting "max. allowed speed" which restricts the charge pump and does not allow it to run at a higher speed than the set value.

For manual operation of the charge pump deactivate "auto" for the current operating mode and set the value to between 1 and 100 % (the previously set value for "max. allowed speed" no longer applies).

Speed in standby mode (only used if "auto" has been selected for "Operating mode") means the charge pump operates at the set speed during the time when there is neither a need for compressor operation nor additional heat.

5.12 - country

Select here where the product was installed. This allows access to country specific settings in your product.

Language settings can be made regardless of this selection.



NOTE

This option locks after 24 hours, restart of display or program updating.

9 Service

Service actions



NOTE

Servicing should only be carried out by persons with the necessary expertise.

When replacing components on SMO 20 only replacement parts from NIBE may be used.

Emergency mode



NOTE

Switch (SF1) must not be put into mode "I" or  before the installation is filled with water. The compressor in the heat pump can be damaged.

Emergency mode is used in event of operational interference and in conjunction with service. Hot water is not produced in emergency mode.

Emergency mode is activated by setting switch (SF1) in mode "". This means that:

- The status lamp illuminates yellow.
- The display is not lit and the control computer is not connected.
- Hot water is not produced.
- The compressors are switched off. Charge pump (EB101-GP12) is running.
- The heating medium pump is active.
- The emergency mode relay (K1) is active.

External additional heat is active if it is connected to the emergency mode relay (K1, terminal block X1). Ensure that the heating medium circulates through the external additional heat.

Temperature sensor data

Temperature (°C)	Resistance (kOhm)	Voltage (VDC)
-40	351.0	3.256
-35	251.6	3.240
-30	182.5	3.218
-25	133.8	3.189
-20	99.22	3.150
-15	74.32	3.105
-10	56.20	3.047
-5	42.89	2.976
0	33.02	2.889
5	25.61	2.789
10	20.02	2.673
15	15.77	2.541
20	12.51	2.399
25	10.00	2.245
30	8.045	2.083
35	6.514	1.916
40	5.306	1.752
45	4.348	1.587
50	3.583	1.426
55	2.968	1.278
60	2.467	1.136
65	2.068	1.007
70	1.739	0.891
75	1.469	0.785
80	1.246	0.691
85	1.061	0.607
90	0.908	0.533
95	0.779	0.469
100	0.672	0.414

USB service outlet

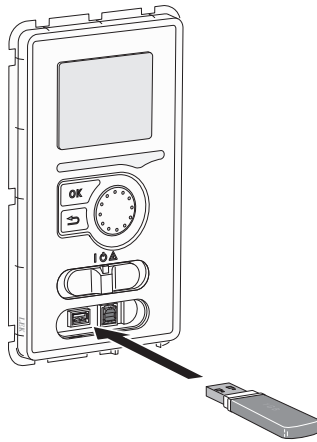

The display unit is equipped with a USB socket that can be used to update the software, save logged information and manage the settings in SMO 20.

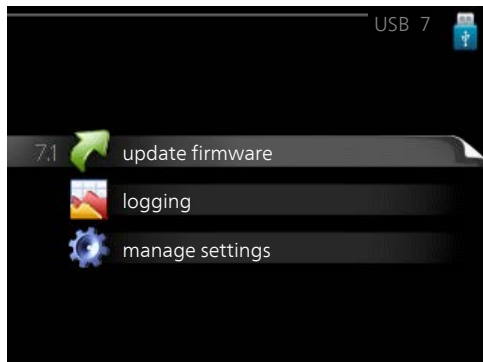
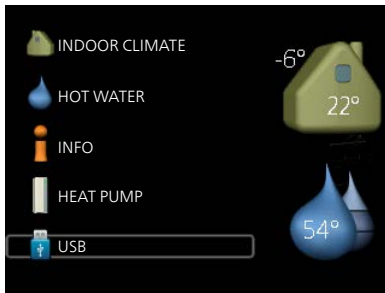

When a USB memory is connected a new menu (menu 7) appears in the display.

Menu 7.1 - update firmware

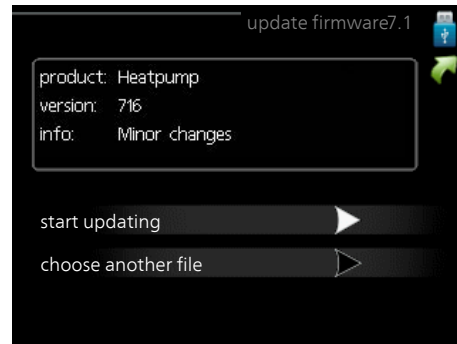

This allows you to update the software in SMO 20.



NOTE

For the following functions to work the USB memory must contain files with software for SMO 20 from NIBE.

The fact box at the top of the display shows information (always in English) of the most probable update that the update software has selected from the USB memory.

This information states which product the software is intended for, the software version and general information about them. If you wish to select another file than the one selected, the correct file can be selected by "choose another file".

start updating

Select "start updating" if you want to start the update. You are asked whether you really want to update the software. Respond "yes" to continue or "no" to undo.

If you responded "yes" to the previous question the update starts and you can now follow the progress of the update on the display. When the update is complete SMO 20 restarts.



NOTE

A software update does not reset the menu settings in SMO 20.



NOTE

If the update is interrupted before it is complete (for example power cut etc.), the software can be reset to the previous version if the OK button is held in during start up until the green lamp starts to illuminate (takes about 10 seconds).

choose another file

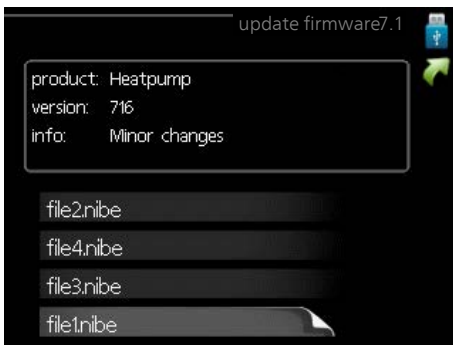

Select "choose another file" if you do not want to use the suggested software. When you scroll through the files, information about the marked software is shown in a fact box just as before. When you have selected a file with the OK button you will return to the previous page (menu 7.1) where you can choose to start the update.

Menu 7.2 - logging

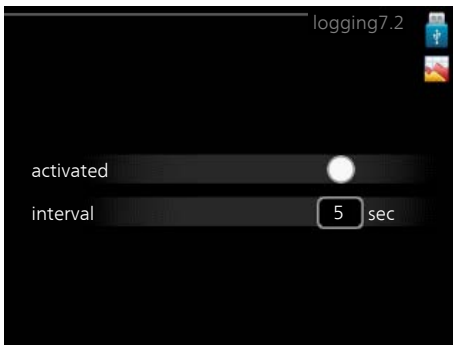

Setting range: 1 s – 60 min
Factory setting range: 5 s

Here you can choose how current measurement values from SMO 20 should be saved onto a log file on the USB memory.

1. Set the desired interval between loggings.
2. Tick "activated".
3. The present values from SMO 20 are saved in a file in the USB memory at the set interval until "activated" is unticked.

NOTE
Untick "activated" before removing the USB memory.

Menu 7.3 - manage settings

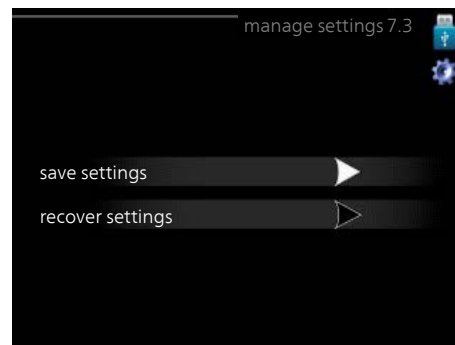

Here you can manage (save as or retrieve from) all the menu settings (user and service menus) in SMO 20 with a USB memory.

Via "save settings" you save the menu settings to the USB memory in order to restore them later or to copy the settings to another SMO 20.

NOTE
When you save the menu settings to the USB memory you replace any previously saved settings on the USB memory.

Via "recover settings" you reset all menu settings from the USB memory.

NOTE
Reset of the menu settings from the USB memory cannot be undone.

10 Disturbances in comfort

In most cases, the control module notes a malfunction and indicates this with alarms and shows instructions to rectify it in the display. See "Manage alarm" for information about managing alarms. If the malfunction does not appear in the display, or if the display is not lit, the following troubleshooting guide can be used.



In the event of an alarm, some kind of malfunction has occurred, which is indicated by the status lamp changing from green continuously to red continuously. In addition, an alarm bell appears in the information window.

Alarm

In the event of an alarm with a red status lamp a malfunction has occurred that the heat pump and/or control module cannot remedy itself. In the display, by turning the control knob and pressing the OK button, you can see the type of alarm it is and reset it. You can also choose to set the installation to aid mode.

info / action Here you can read what the alarm means and receive tips on what you can do to correct the problem that caused the alarm.

reset alarm In many cases, it is sufficient to select "reset alarm" in order for the product to revert to normal operation. If a green light comes on after selecting "reset alarm", the alarm has been remedied. If a red light is still visible and a menu called "alarm" is visible in the display, the problem that caused the alarm remains. If the alarm disappears and then returns, see the troubleshooting section (page 44).

aid mode "aid mode" is a type of emergency mode. This means that the installation produces heat and/or hot water despite there being some kind of problem. This can mean that the heat pump's compressor is not running. In this case any electrical addition produces heat and/or hot water.



NOTE

To select aid mode an alarm action must be selected in the menu 5.1.4.



Caution

Selecting "aid mode" is not the same as correcting the problem that caused the alarm. The status lamp will therefore continue to be red.

Troubleshooting

If the operational interference is not shown in the display the following tips can be used:

Basic actions

Start by checking the following items:

- The switch's (SF1) position.
- Group and main fuses of the accommodation.
- The property's earth circuit breaker.
- The control module's miniature circuit breaker (FA1).

Low hot water temperature or no hot water

This part of the fault-tracing chapter only applies if the water heater is installed in the system.

- Closed or choked filling valve for the hot water.
 - Open the valve.
- Mixing valve (if there is one installed) set too low.
 - Adjust the mixer valve.
- Control module in incorrect operating mode.
 - If mode "manual" is selected, select "addition".
- Large hot water consumption.
 - Wait until the hot water has heated up. Temporarily increased hot water capacity (temporary lux) can be activated in menu 2.1.
- Too low hot water setting.
 - Enter menu 2.2 and select a higher comfort mode.
- Too low or no operating prioritisation of hot water.
 - Enter menu 4.9.1 and increase the time for when hot water is to be prioritised.

Low room temperature

- Closed thermostats in several rooms.
 - Set the thermostats to max, in as many rooms as possible. Adjust the room temperature via menu 1.1, instead of choking the thermostats.
- Control module in incorrect operating mode.
 - Enter menu 4.2. If mode "auto" is selected, select a higher value on "stop heating" in menu 4.9.2.
 - If mode "manual" is selected, select "heating". If this is not enough, select "addition".
- Too low set value on the automatic heating control.
 - Enter menu 1.1 "temperature" and adjust the offset heating curve up. If the room temperature is only low in cold weather the curve slope in menu 1.9.1 "heating curve" needs adjusting up.
- Too low or no operating prioritisation of heat.
 - Enter menu 4.9.1 and increase the time for when heating is to be prioritised.
- "Holiday mode" activated in menu 4.7.
 - Enter menu 4.7 and select "Off".
- External switch for changing the room heating activated.
 - Check any external switches.
- Air in the climate system.
 - Vent the climate system.

High room temperature

- Too high set value on the automatic heating control.
 - Enter menu 1.1 (temperature) and reduce the offset heating curve. If the room temperature is only high in cold weather the curve slope in menu 1.9.1 "heating curve" needs adjusting down.
- External switch for changing the room heating activated.
 - Check any external switches.

Low system pressure

- Not enough water in the climate system.
 - Fill the climate system with water and check for leaks. In event of repeated filling, contact the installer.

The compressor does not start

- There is no heating requirement.
 - SMO 20 does not call on heating or hot water.
- Compressor blocked due to the temperature conditions.
 - Wait until the temperature is within the product's working range.
- Minimum time between compressor starts has not been reached.
 - Wait 30 minutes and then check if the compressor has started.
- Alarm tripped.
 - Follow the display instructions.

Additional heating only

If you are unsuccessful in rectifying the fault and are unable to heat the house, you can, whilst waiting for assistance, continue running the heat pump in "add. heat only". This means that additional heating only is used to heat the house.

Set the installation to additional heat mode

1. Go to menu 4.2 op. mode.
2. Mark "add. heat only" using the control knob and then press the OK button.
3. Return to the main menus by pressing the Back button.



Caution

When commissioning without NIBE air/water heat pump, the communication error alarm may appear in the display.

The alarm is reset if the relevant heat pump is deactivated in menu 5.2.2 ("installed heat pump").

11 Accessories

Not all accessories are available on all markets.

Air/water heat pump

NIBE SPLIT HBS 05

AMS 10-6

Part no. 064 205

HBS 05-6

Part no. 067 578

AMS 10-8

Part no. 064 033

HBS 05-12

Part no. 067 480

AMS 10-12

Part no. 064 110

HBS 05-12

Part no. 067 480

AMS 10-16

Part no. 064 035

HBS 05-16

Part no. 067 536

F2040

F2040-6

Part no. 064 206

F2040-8

Part no. 064 109

F2040-12

Part no. 064 092

F2040-16

Part no. 064 108

F2120

F2120-8 1x230V

Part no. 064 134

F2120-8 3x400V

Part no. 064 135

F2120-12 1x230V

Part no. 064 136

F2120-12 3x400V

Part no. 064 137

F2120-16 3x400V

Part no. 064 139

F2120-20 3x400V

Part no. 064 141

Auxiliary relay HR 10

Auxiliary relay HR 10 is used to control external 1 to 3 phase loads such as oil burners, immersion heaters and pumps.

Part no 067 309

Charge pump CPD 11

Charge pump for heat pump

CPD 11-25/65

Part no. 067 321

CPD 11-25/75

Part no. 067 320

Connection box K11

Connection box with thermostat and overheating protection. (When connecting Immersion heater IU)

Part no. 018 893

External electric additional heat ELK

ELK 15

15 kW, 3 x 400 V
Part no. 069 022

ELK 26

26 kW, 3 x 400 V
Part no. 067 074

ELK 213

7-13 kW, 3 x 400 V
Part no. 069 500

Hot water control

VST 05

Reversing valve, Cu pipe Ø22 mm
Max. heat pump size 8 kW
Part no. 089 982

VST 11

Reversing valve, Cu pipe Ø28 mm
(Max. recommended capacity, 17 kW)
Part no. 089 152

VST 20

Reversing valve, Cu pipe Ø35 mm
(Max. recommended capacity, 40 kW)
Part no 089 388

Immersion heater IU

3 kW

Part no. 018 084

6 kW

Part no. 018 088

9 kW

Part no. 018 090

Reversing valve for cooling

VCC 05

Reversing valve, Cu pipe Ø22 mm
Part no. 067 311

VCC 11

Reversing valve, Cu pipe Ø28 mm
Part no. 067 312

Room sensor RTS 40

This accessory is used to obtain a more even indoor temperature.

Part no. 067 065

Water heater/Accumulator tank

AHPS

Accumulator tank without an immersion heater with solar coil (copper) and a hot water coil (stainless steel).

Part no. 056 283

AHPH

Accumulator tank without an immersion heater with integrated hot water coil (stainless steel).

Part no. 081 036

VPA

Water heater with double-jacketed vessel.

VPA 450/300

Copper Part no. 088 660

Enamel Part no. 088 670

VPB

Water heater without immersion heater with charging coil.

VPB 200

Copper Part no. 088 515

Enamel Part no. 088 517

Stainless steel Part no. 088 518

VPB 300

Copper Part no. 083 009

Enamel Part no. 083 011

Stainless steel Part no. 083 010

VPB 500

Copper Part no. 083 220

VPB 750-2

Copper Part no. 083 231

VPB 1000

Copper Part no. 083 240

VPAS

Water heater with double-jacketed vessel and solar coil.

VPAS 300/450

Copper Part no. 087 720

Enamel Part no. 087 710

12 Technical data

Dimensions

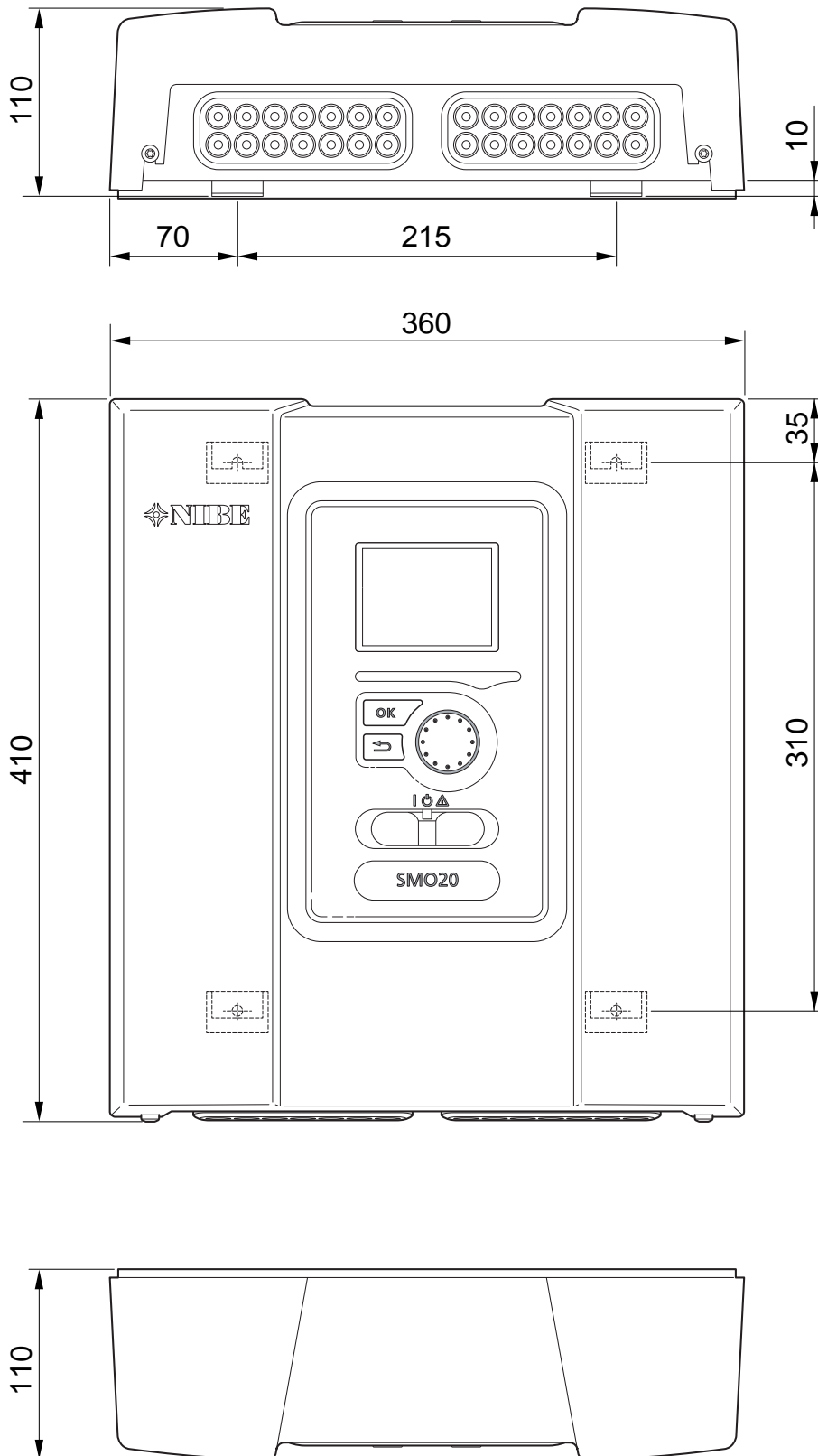

Technical specifications



SMO 20		
Electrical data		
Supply voltage		230V~ 50Hz
Enclosure class		IP21
Rated value for impulse voltage	kV	4
Pollution degree		2
Fuse	A	10
Optional connections		
Max number air/water heat pumps		1
Max number of sensors		8
Max number of charge pumps		1
Max number of outputs for additional heat step		3

Miscellaneous		
Operation mode (EN60730)		Type 1
Area of operation	°C	-25 – 70
Ambient temperature	°C	5 – 35
Program cycles, hours		1, 24
Program cycles, days		1, 2, 5, 7
Resolution, program	min.	1
Dimensions and weight		
Width	mm	360
Depth	mm	110
Height	mm	410
Weight, (without packaging and enclosed components)	kg	4.3
Part No.		067 224

Energy labelling

Supplier		NIBE	
Model		SMO 20 + F2030 / F2300	SMO 20 + F2040 / F2120
Controller, class		III	II
Controller, contribution to efficiency	%	1.5	2.0

Electrical circuit diagram

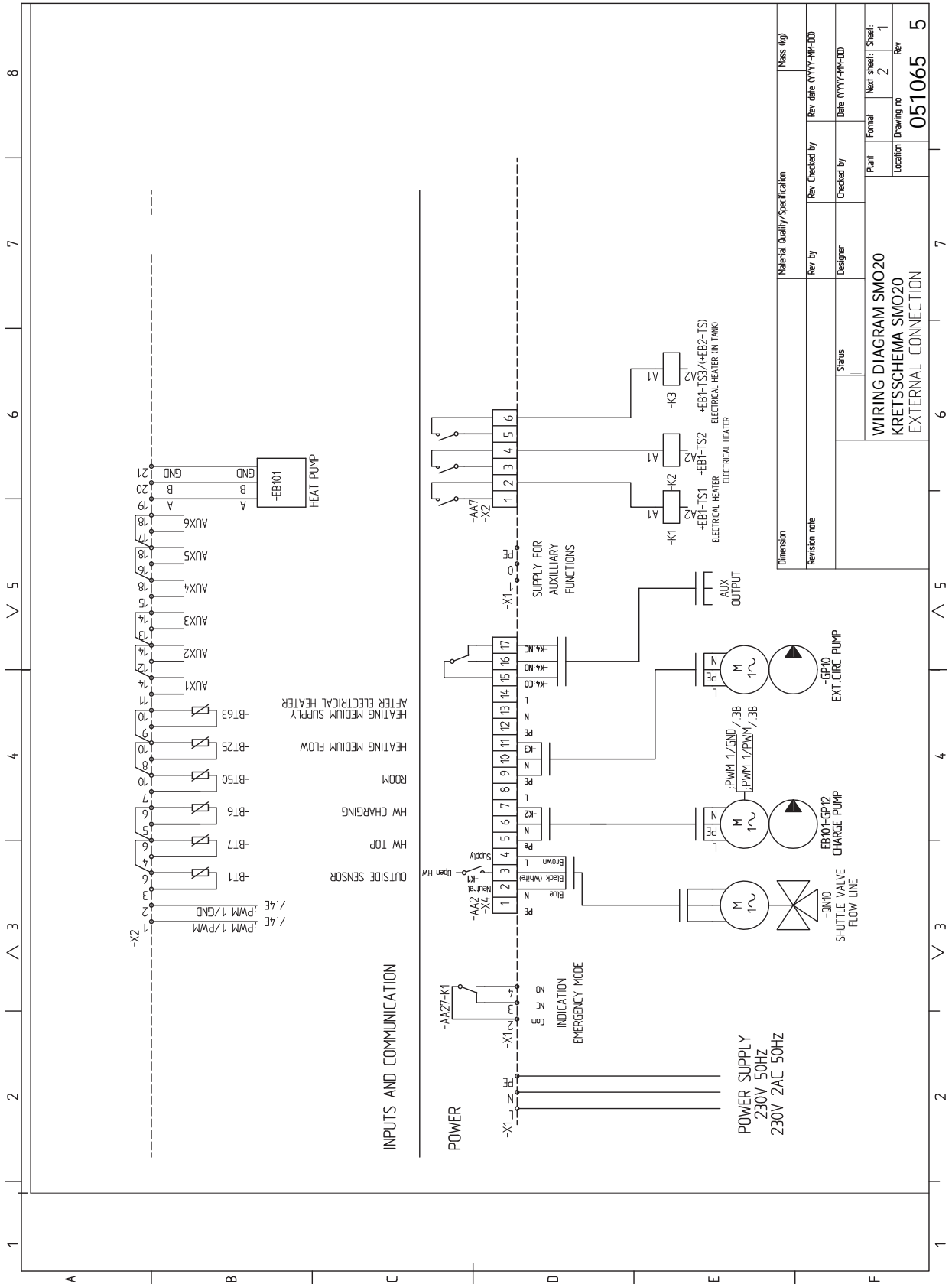

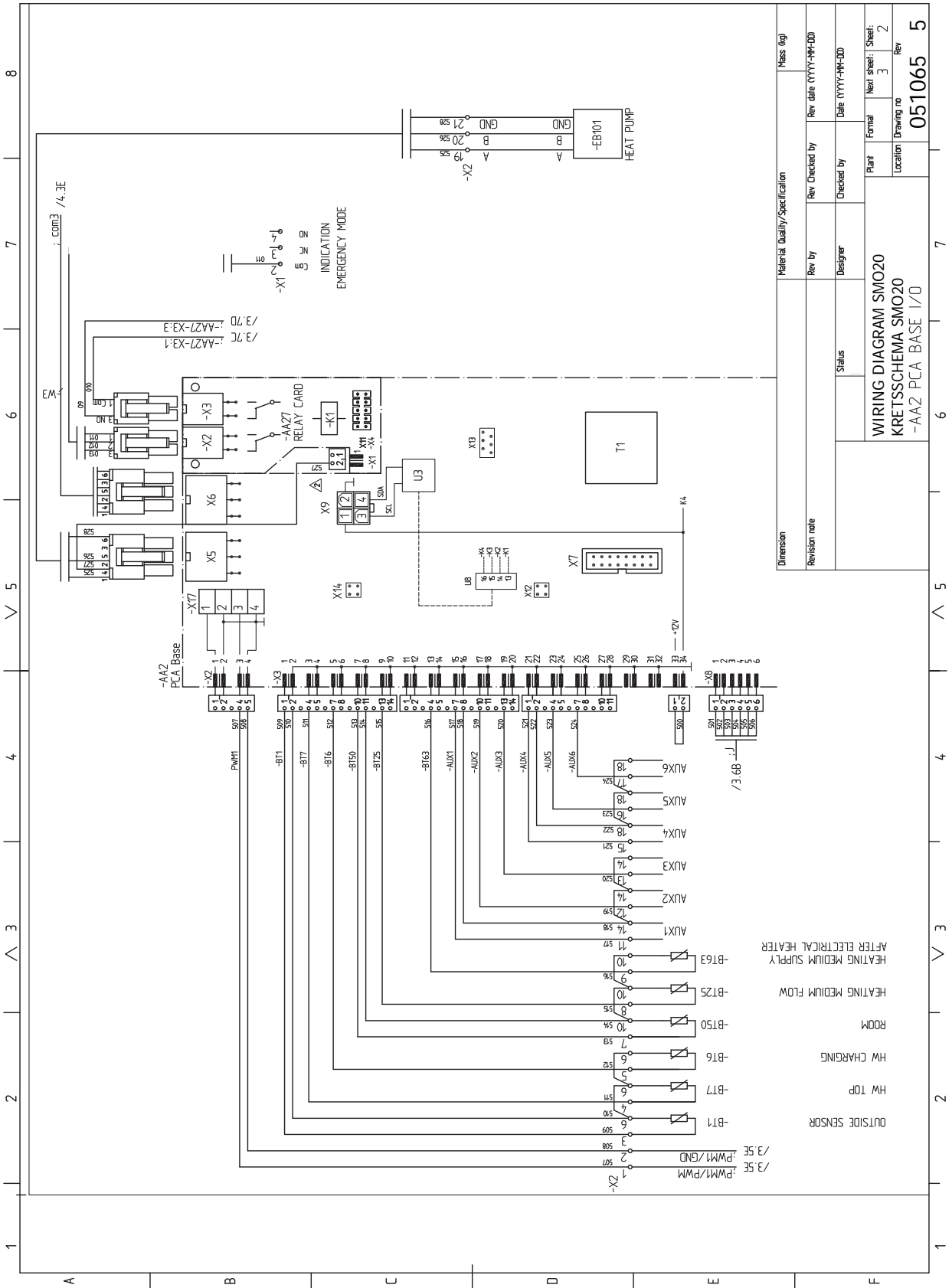

Material Quality/Specification	Mass (kg)
Revision note	Rev. Checked by
	Rev. date (YYYY-MM-DD)
	Designer
	Checked by
	Date (YYYY-MM-DD)
	Plant
	Formal
	Next sheet:
	Sheet:
	Location
	Drawing no
	Rev
	051065
	5

WIRING DIAGRAM SMO20
KRETSSCHEMA SMO20
-AA2 PCA BASE I/O

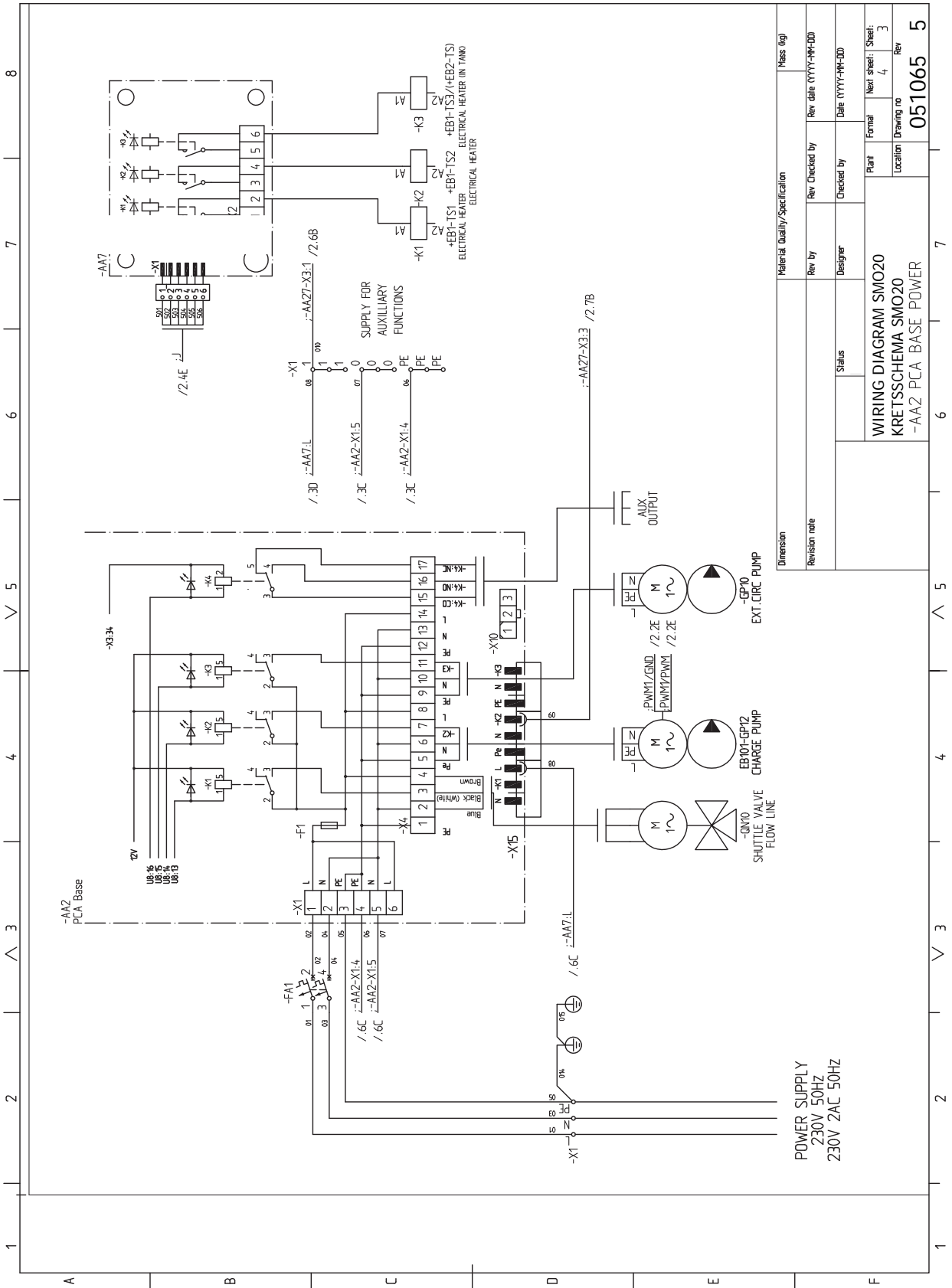

13 Item register

Item register

A

Accessibility, electrical connection, 16
Accessories, 46
Alarm, 44

B

Back button, 29

C

Cable lock, 17
Commissioning and adjusting, 27
 Commissioning with additional heating only, 27
 Commissioning with NIBE air/water heat pump, 27
 Cooling mode, 27
 Preparations, 27
 Start guide, 28
Commissioning with additional heating only, 27
Commissioning with NIBE air/water heat pump, 27
Communication with heat pump, 19
Connecting accessories, 26
Connecting the charge pump for the heat pump, 18
Connections, 18
Contact for activation of "external adjustment", 24
Contact for activation of "temporary lux", 24
Contact for external tariff blocking, 23
Control, 29, 33
 Control - Introduction, 29
 Control - Menus, 33
Control - Introduction, 29
 Display unit, 29
 Menu system, 30
Control knob, 29
Control - Menus, 33
 Menu 5 - SERVICE, 36
Cooling mode, 27
Cooling mode indication, 24

D

Delivery and handling, 7
 Mounting, 7
 Supplied components, 7
Dimensions and setting-out coordinates, 48
Display, 29
Display unit, 29
 Back button, 29
 Control knob, 29
 Display, 29
 OK button, 29
 Status lamp, 29
 Switch, 29
Disturbances in comfort, 44
 Alarm, 44
 Manage alarm, 44
 Only additional heat, 45
 Troubleshooting, 44
Docking alternatives, 10

E

Electrical circuit diagram, 51
Electrical connections, 15
 Accessibility, electrical connection, 16
 Cable lock, 17
 Communication with heat pump, 19
 Connecting accessories, 26
 Connecting the charge pump for the heat pump, 18
 Connections, 18
 External circulation pump, 22
 External connection options, 23
 General, 15

 Miniature circuit-breaker, 15
 NIBE Uplink, 22
 Optional connections, 21
 Outdoor sensor, 19
 Power connection, 18
 Relay output for emergency mode, 22
 Reversing valve, 22
 Room sensor, 21
 Step controlled additional heat, 21
 Temperature sensor, external flow line, 20
 Temperature sensor, external supply line after electric heater, 20
 Temperature sensor, hot water charging, 19

Energy labelling, 50

External circulation pump, 22

External connection options, 23

 Contact for activation of "external adjustment", 24
 Contact for activation of "temporary lux", 24
 Contact for external tariff blocking, 23
 Cooling mode indication, 24
 Extra circulation pump, 24
 Hot water circulation, 24
 Possible selection for AUX inputs, 23
 Possible selection for AUX output (potential free variable relay), 24
 Switch for "Smart Grid ready", 23
 Switch for activation of external alarm, 24
 Switch for external blocking of function, 24
 Temperature sensor, cooling/heating, 23
 Temperature sensor, external flow line, 23
 Temperature sensor, flow line cooling, 23
 Temperature sensor, hot water top, 19

Extra circulation pump, 24

H

Help menu, 28, 32
Hot water circulation, 24

I

Important information, 4
 Recovery, 5
 Safety information, 4
Inspection of the installation, 6

M

Manage alarm, 44
Marking, 4
Menu 5 - SERVICE, 36
Menu system, 30
 Help menu, 28, 32
 Operation, 31
 Scroll through the windows, 32
 Selecting menu, 31
 Selecting options, 31
 Setting a value, 31
 Use the virtual keyboard, 32
Miniature circuit-breaker, 15
Mounting, 7

N

NIBE Uplink, 22

O

OK button, 29
Only additional heat, 45
Operation, 31
Optional connections, 21
Outdoor sensor, 19

P

- Pipe connections, 9
 - Docking alternatives, 10
 - General, 9
 - Symbol key, 9
- Possible selection for AUX inputs, 23
- Possible selection for AUX output (potential free variable relay), 24
- Power connection, 18
- Preparations, 27

R

- Relay output for emergency mode, 22
- Reversing valve, 22
- Room sensor, 21

S

- Safety information, 4
 - Inspection of the installation, 6
 - Marking, 4
 - Serial number, 5
 - Symbols, 4
 - Symbols on SMO 20, 4
- Scroll through the windows, 32
- Selecting menu, 31
- Selecting options, 31
- Service, 41
 - Service actions, 41
- Service actions, 41
 - Standby mode, 41
 - Temperature sensor data, 41
 - USB service outlet, 42
- Setting a value, 31
- Standby mode, 41
- Start guide, 28
- Status lamp, 29
- Step controlled additional heat, 21
- Supplied components, 7
- Switch, 29
 - Switch for "Smart Grid ready", 23
 - Switch for activation of external alarm, 24
 - Switch for external blocking of function, 24
- Symbol key, 9
- Symbols, 4
 - Symbols on SMO 20, 4

T

- Technical data, 48
 - Dimensions and setting-out coordinates, 48
- Temperature sensor, cooling/heating, 23
- Temperature sensor, external flow line, 20, 23
- Temperature sensor, external supply line after electric heater, 20
- Temperature sensor, flow line cooling, 23
- Temperature sensor, hot water charging, 19
- Temperature sensor, hot water top, 19
- Temperature sensor data, 41
- The Control Module Design, 8
 - Component locations, 8
 - List of components, 8
- Troubleshooting, 44

U

- USB service outlet, 42
- Use the virtual keyboard, 32

Contact information

- AT** **KNV Energietechnik GmbH**, Gahberggasse 11, AT-4861 Schörfling
Tel: +43 (0)7662 8963 E-mail: mail@knv.at www.knv.at
- CH** **NIBE Wärmetechnik c/o ait Schweiz AG**, Industriepark, CH-6246 Altishofen
Tel: +41 58 252 21 00 E-mail: info@nibe.ch www.nibe.ch
- CZ** **Druzstevni zavody Drazice s.r.o.**, Drazice 69, CZ - 294 71 Benátky nad Jizerou
Tel: +420 326 373 801 E-mail: nibe@nibe.cz www.nibe.cz
- DE** **NIBE Systemtechnik GmbH**, Am Reiherpfahl 3, 29223 Celle
Tel: +49 (0)5141 7546-0 E-mail: info@nibe.de www.nibe.de
- DK** **Vølund Varmeteknik A/S**, Member of the Nibe Group, Brogårdsvej 7, 6920 Videbæk
Tel: +45 97 17 20 33 E-mail: info@volundvt.dk www.volundvt.dk
- FI** **NIBE Energy Systems OY**, Juurakkotie 3, 01510 Vantaa
Tel: +358 (0)9-274 6970 E-mail: info@nibe.fi www.nibe.fi
- FR** **NIBE Energy Systems France Sarl**, Zone industrielle RD 28, Rue du Pou du Ciel, 01600 Reyrieux
Tel : 04 74 00 92 92 E-mail: info@nibe.fr www.nibe.fr
- GB** **NIBE Energy Systems Ltd**, 3C Broom Business Park, Bridge Way, S419QG Chesterfield
Tel: +44 (0)845 095 1200 E-mail: info@nibe.co.uk www.nibe.co.uk
- NL** **NIBE Energietechniek B.V.**, Postbus 634, NL 4900 AP Oosterhout
Tel: 0168 477722 E-mail: info@nibenl.nl www.nibenl.nl
- NO** **ABK AS**, Brobekkveien 80, 0582 Oslo, Postadresse: Postboks 64 Vollebakk, 0516 Oslo
Tel: +47 23 17 05 20 E-mail: post@abkklima.no www.nibeenergysystems.no
- PL** **NIBE-BIAWAR Sp. z o. o.** Aleja Jana Pawła II 57, 15-703 BIALYSTOK
Tel: +48 (0)85 662 84 90 E-mail: sekretariat@biawar.com.pl www.biawar.com.pl
- RU** © "EVAN" 17, per. Boynovskiy, RU-603024 Nizhny Novgorod
Tel: +7 831 419 57 06 E-mail: kuzmin@evan.ru www.nibe-evan.ru
- SE** **NIBE AB Sweden**, Box 14, Hannabadsvägen 5, SE-285 21 Markaryd
Tel: +46 (0)433 73 000 E-mail: info@nibe.se www.nibe.se

For countries not mention in this list, please contact Nibe Sweden or check www.nibe.eu for more information.

NIBE AB Sweden
Hannabadsvägen 5
Box 14
SE-285 21 Markaryd
info@nibe.se
www.nibe.eu

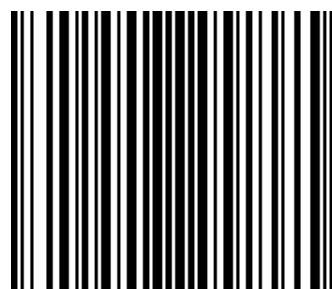

231758